



MONITOR WITH DVD RECEIVER
 MONITOR CON RECEPTOR DE DVD
 MONITEUR AVEC RÉCEPTEUR DVD

ENGLISH

ESPAÑOL

FRANÇAIS

KW-ADV65BT/KW-AV61BT/ KW-AV61



This instruction manual is used to describe models listed below.

- Region 1 (DVD Region Code 1 area)/Region 4 (DVD Region Code 4 area)

En este manual de instrucciones se describen los modelos listados a continuación.

- Región 1 (DVD Código de región Área 1)/Región 4 (DVD Código de región Área 4)

Ce mode d'emploi est utilisé pour décrire les modèles de la liste ci-dessous.

- Région 1 (zone de code de région DVD 1)/Région 4 (zone de code de région DVD 4)

For canceling the display demonstration, see page 7.
 Para cancelar la demostración en pantalla, consulte la página 7.
 Pour annuler la démonstration des affichages, référez-vous à la page 7.

For customer Use:
 Enter below the Model No. and
 Serial No. which are located on
 the top or bottom of the cabinet.
 Retain this information for future
 reference.

Model No. _____
 Serial No. _____

For installation and connections, refer to the separate manual.
 Para la instalación y las conexiones, refiérase al manual separado.
 Pour l'installation et les raccordements, se référer au manuel séparé.

INSTRUCTION MANUAL MANUAL DE INSTRUCCIONES MODE D'EMPLOI

JVC KENWOOD Corporation

GET0884-001A
 [J/JW]



Thank you for purchasing a JVC product.

Please read all instructions carefully before operation, to ensure your complete understanding and to obtain the best possible performance from the unit.

WARNINGS: (To prevent accidents and damage)

- DO NOT install any unit or wire any cable in a location where;
 - it may obstruct the steering wheel and gearshift lever operations.
 - it may obstruct the operation of safety devices such as air bags.
 - it may obstruct visibility.
- DO NOT operate the unit while driving.
If you need to operate the unit while driving, be sure to look around carefully.
- The driver must not watch the monitor while driving.
- The driver must not put on the headphones while driving.

CAUTION

Use of controls or adjustments or performance of procedures other than those specified herein may result in hazardous radiation exposure. In compliance with Federal Regulations, following are reproductions of labels on, or inside the product relating to laser product safety.

JVC KENWOOD Corporation
2967-3, ISHIKAWA-MACHI, HACHIOJI-SHI, TOKYO, JAPAN

THIS PRODUCT COMPLIES WITH DHHS RULES
21CFR SUBCHAPTER J IN EFFECT AT DATE OF
MANUFACTURE.

Location : Top plate

For KW-AV61BT Region 4/KW-AV61 Region 4: The marking of products using lasers



The label is attached to the chassis/case and says that the component uses laser beams that have been classified as Class 1. It means that the unit is utilizing laser beams that are of a weaker class. There is no danger of hazardous radiation outside the unit.

For KW-ADV65BT/KW-AV61BT Region 1/KW-AV61 Region 1:

FCC WARNING

This equipment may generate or use radio frequency energy. Changes or modifications to this equipment may cause harmful interference unless the modifications are expressly approved in the instruction manual. The user could lose the authority to operate this equipment if an unauthorized change or modification is made.

FCC NOTE

This equipment has been tested and found to comply with the limits for a Class B digital device, pursuant to Part 15 of the FCC Rules. These limits are designed to provide reasonable protection against harmful interference in a residential installation. This equipment may cause harmful interference to radio communications, if it is not installed and used in accordance with the instructions. However, there is no guarantee that interference will not occur in a particular installation. If this equipment does cause harmful interference to radio or television reception, which can be determined by turning the equipment off and on, the user is encouraged to try to correct the interference by one or more of the following measures:

- Reorient or relocate the receiving antenna.
- Increase the separation between the equipment and receiver.
- Connect the equipment into an outlet on a circuit different from that to which the receiver is connected.
- Consult the dealer or an experienced radio/TV technician for help.

Cautions on the monitor:

- The monitor built in this unit has been produced with high precision, but it may have some ineffective dots. This is inevitable and is not considered defective.
- Do not expose the monitor to direct sunlight.
- Do not operate the touch panel using a ball-point pen or similar tool with the sharp tip.
Touch the buttons on the touch panel with your finger directly (if you are wearing a glove, take it off).
- When the temperature is very cold or very hot...
 - Chemical changes occur inside, causing malfunction.
 - Pictures may not appear clearly or may move slowly. Pictures may not be synchronized with the sound or picture quality may decline in such environments.

For safety...

- Do not raise the volume level too much, as this will make driving dangerous by blocking outside sounds, and may cause hearing loss.
- Stop the car before performing any complicated operations.

Temperature inside the car...

If you have parked the car for a long time in hot or cold weather, wait until the temperature in the car becomes normal before operating the unit.

■ How to reset your unit

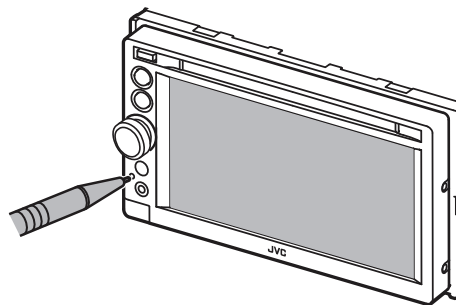

- Your preset adjustments will also be erased (except the registered Bluetooth devices).

■ How to forcibly eject a disc

Press SRC/⏻ and ▲ on the monitor panel at the same time.

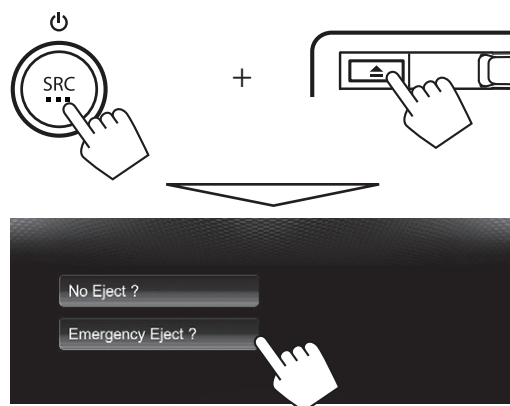

- *Be careful not to drop the disc when it ejects.*
- *If this does not work, reset your unit. (☞ above)*

How to read this manual:

- Illustrations of KW-ADV65BT are mainly used for explanation.
- This manual mainly explains operations using the buttons on the monitor panel and touch panel. For operations using the remote controller (RM-RK256: supplied only for KW-ADV65BT/KW-AV61BT Region 4/ KW-AV61 Region 4), ☞ page 62.
- < > indicates the variable screens/menus/operations/settings that appear on the touch panel.
- [] indicates the buttons on the touch panel.
- **Indication language:** English indications are used for the purpose of explanation. You can select the indication language from the <Settings> menu. (☞ page 48)

Contents

How to reset your unit	3
How to forcibly eject a disc	3

INTRODUCTIONS

Detaching/attaching the monitor panel...	5
Component names and functions	6
Initial settings	7
Setting the clock	8
Common operations	9
Turning on the power	9
Turning off the power	9
Adjusting the volume	9
Turning off the screen	9
Turning on/off the AV source	10
Touch screen operation.....	10
Switching screens	11

AV SOURCE OPERATIONS

Selecting the playback source	12
Listening to the radio	13
Disc operations.....	17
Playing a disc.....	17
Playable disc types	18
Playback operations	19
Settings for disc playback.....	23
USB operations.....	24
Playing a USB device	24
Listening to the iPod/iPhone device	26
Preparation	26
Setting iPod control mode.....	27
Selecting preference settings for iPod/iPhone playback.....	27
iPod/iPhone playback operations for <Head> mode.....	28
iPod/iPhone playback operations for <iPod Out> mode.....	29
Using an App of iPod touch/iPhone	30
Pandora® operations for KW-ADV65BT/ KW-AV61BT Region 1/ KW-AV61 Region 1	32
Using other external components.....	34
Front AUX	34
AV-IN	34

Listening to the SiriusXM™ Radio for KW-ADV65BT/KW-AV61BT Region 1/ KW-AV61 Region 1	35
Activating subscription.....	35
Tuning in to a channel	35
Setting the reception restrictions	37
Sound adjustment.....	39
Using the sound equalization	39
Adjusting the crossover frequency.....	40
Changing display design	41
Setting for video playback	43
Adjusting the picture.....	43
Changing the aspect ratio	44
Zooming the picture.....	44
Using a rear view camera	45
Setting menu items.....	46
Memorizing/recalling the settings	49
Updating the system	50
Adjusting the touch position	50

BLUETOOTH OPERATIONS

Information for using Bluetooth® devices.....	51
Bluetooth operations for KW-ADV65BT/ KW-AV61BT	51
Connecting Bluetooth devices	52
Setting up Bluetooth.....	54
Using the Bluetooth mobile phone.....	55
Settings for Bluetooth mobile phones.....	59
Using the Bluetooth audio player	60
Bluetooth operations for KW-AV61	61
Using the Bluetooth mobile phone	61
Using the Bluetooth audio player	61

REFERENCE

Using the remote controller	62
Operations using the remote controller (RM-RK256)	62
Maintenance	65
More about this unit.....	66
Troubleshooting.....	69
Specifications.....	74

INTRODUCTIONS

Detaching/attaching the monitor panel

Cautions

- Hold the monitor panel securely so as not to drop it accidentally.
- Fit the monitor panel onto the attaching plate until it is firmly locked.

■ Detaching

Turn off the power before detaching the monitor panel.

(☞ page 9)

1

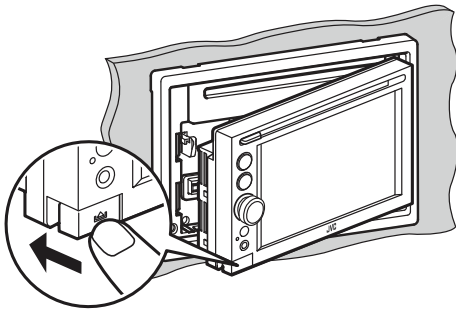

2

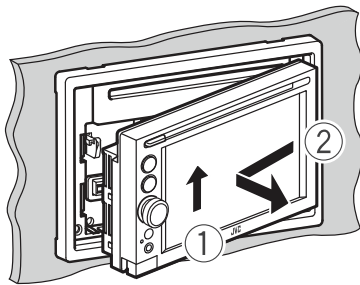

■ Attaching

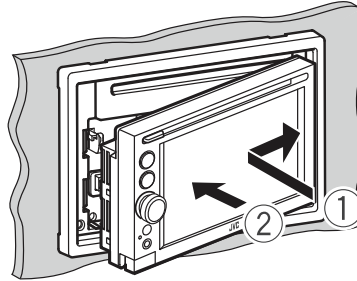

Component names and functions

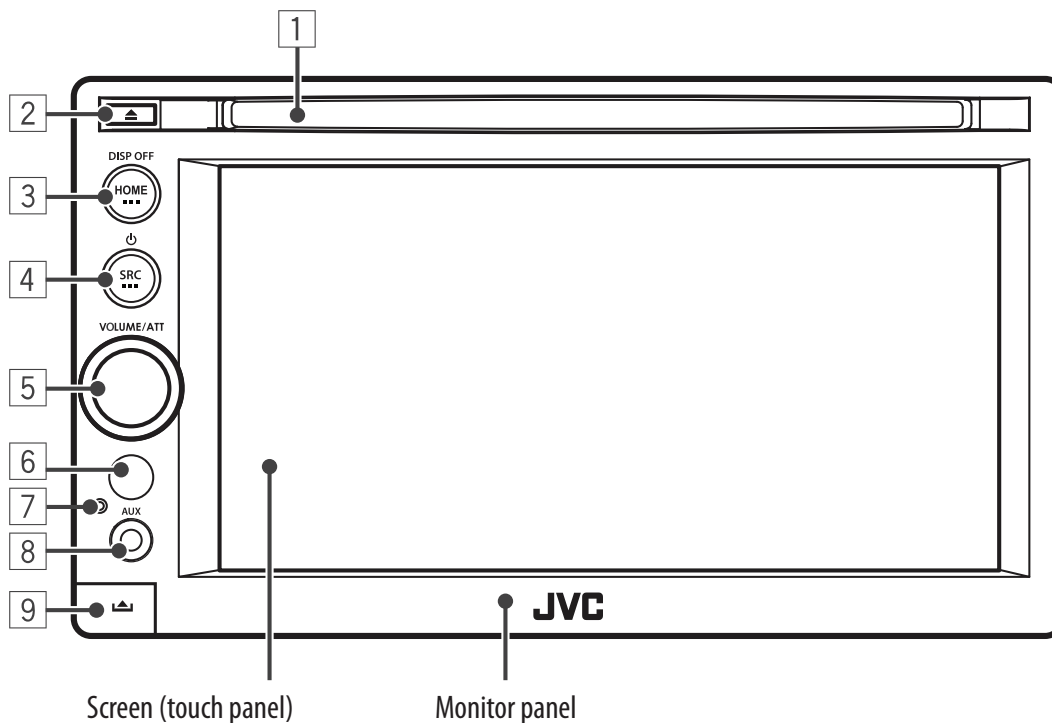

- 1 Loading slot
- 2 ▲ (Eject) button
Ejects the disc.
- 3 HOME/DISP OFF button
 - Displays the <HOME> screen. (Press) (↗ page 12)
 - Turns off/on the screen. (Hold) (↗ page 9)
- 4 SRC/⏻ button
 - Turns off the power. (Hold) (↗ page 9)
 - Turns on the power. (Press) (↗ page 9)
 - Selects the AV source. (Press) (↗ page 12)
- 5 VOLUME/ATT knob. (↗ page 9)
 - Attenuates the sound. (Press)
 - Adjusts the audio volume. (Turn)
- 6 Remote sensor
- 7 Reset button
Resets the unit. (↗ page 3)
- 8 AUX input jack
- 9 ▲ (Detach) button
Detaches the monitor panel. (↗ page 5)

Caution on the volume setting:

Digital devices produce very little noise compared with other sources. Lower the volume before playing these digital sources to avoid damaging the speakers by sudden increase of the output level.

You can change the color of the buttons on the monitor panel. (↗ page 41)

Initial settings

When you power on the unit for the first time or reset the unit, the initial setting screen appears.

- You can also change the settings on the <Settings> screen. (☞ page 46)

1 For KW-ADV65BT/KW-AV61BT

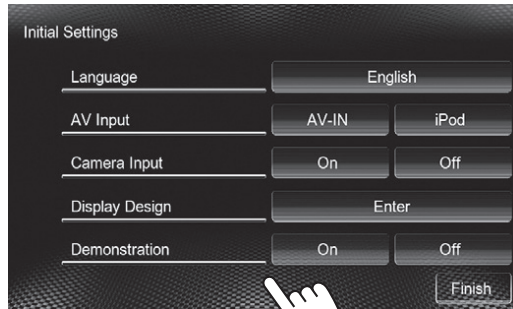

For KW-AV61

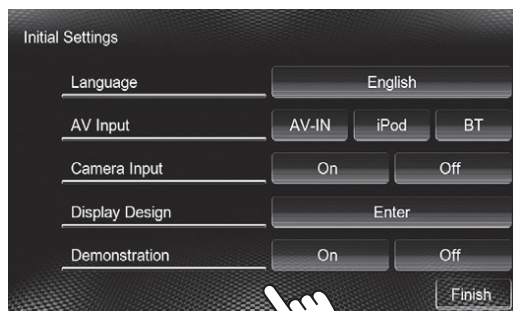

Language	Select the text language used for on-screen information. (☞ page 48) <ul style="list-style-type: none"> Set <GUI Language> to display the operation buttons and menu items in the selected language ([Local]: initially selected) or English ([English]).
AV Input	Select an external component to play. (☞ page 47)
Camera Input	Select [On] when connecting the rear view camera. (☞ page 48)
Display Design	Select the background and the colors of the text, touch panel buttons and the monitor panel buttons. (☞ page 41)
Demonstration	Activate or deactivate the display demonstration. (☞ page 47)

2 Finish the procedure.

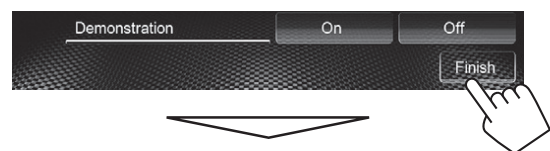

The <HOME> screen is displayed.

- [AV Off] is selected initially. Select the playback source. (☞ page 12)

Setting the clock

1 Display the <HOME> screen.

On the source control screen:



2 Display the <Settings> screen.



3 Display the <Time Set> screen.

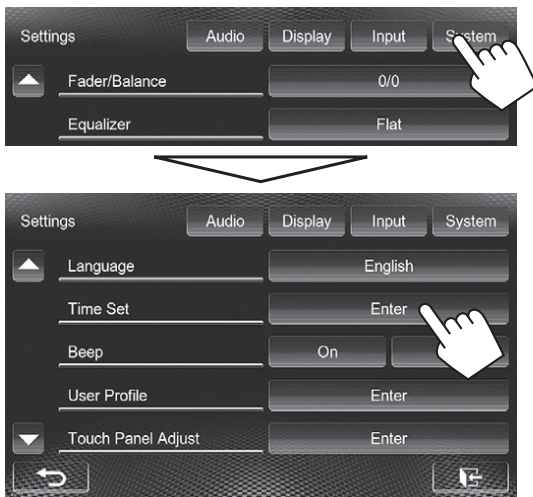

4 Set the clock time.

To synchronize the clock time with FM RBDS

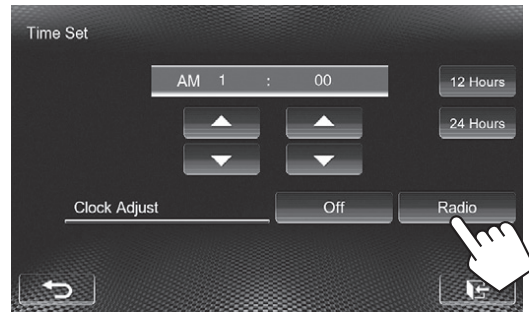

To set the clock manually

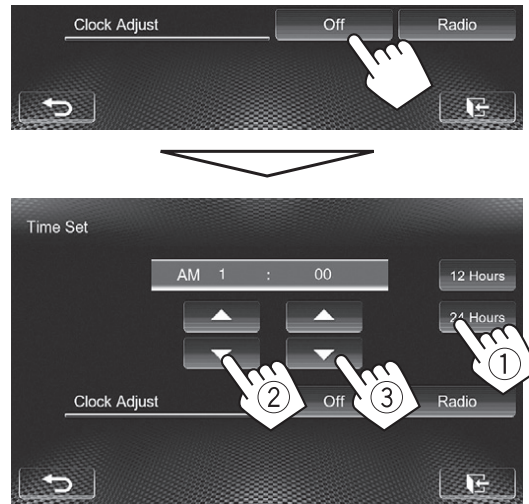

- ① Select the time display format
- ② Adjust the hour
- ③ Adjust the minute

5 Finish the procedure.



Common operations

Turning on the power



Turning off the power

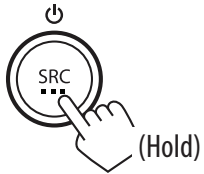

Adjusting the volume

To adjust the volume (00 to 50)

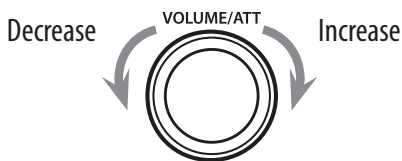

- On the source control screen, you can also adjust the volume by moving your finger on the touch panel as illustrated. (Not available depending on the AV source.)

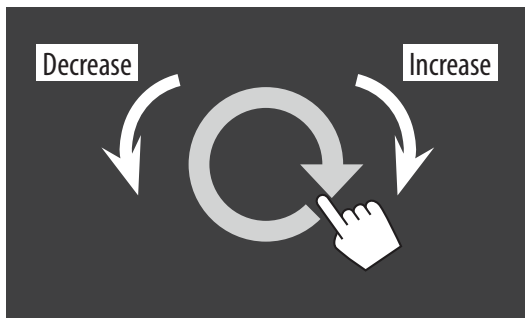

To attenuate the sound



The ATT indicator lights up.

To cancel the attenuation, press the VOLUME/ATT knob.

Turning off the screen

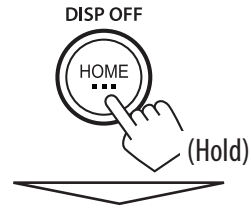

The screen is turned off.

- You can also turn off the screen on the <HOME> screen.



To turn on the screen



or

Touch the screen to display the <HOME> screen.

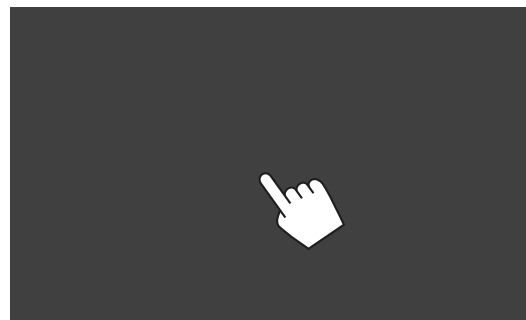

Turning on/off the AV source

You can activate the AV function by selecting source on <HOME> screen.



To turn off the AV source



The AV source is turned off.

Touch screen operation

(A) Displays the video control menu while playing a video.

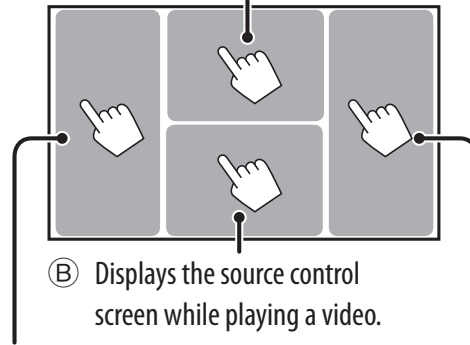

(B) Displays the source control screen while playing a video.

Goes to the previous chapter/track.*

Goes to the next chapter/track.*

(A) Video control menu



(B) Source control screen for video playback



- The operation buttons disappear by touching the screen or when no operation is done for about 10 seconds.

* Not available for video from an external component. Dragging your finger to left or right functions in the same way as touching.

Switching screens

Source control screen



- Pressing HOME on the monitor panel also displays the <HOME> screen.

Common operating buttons

*1	Displays the screen of App from the connected iPod touch/iPhone. (☞ page 30)
*2*3	Displays the phone control screen. (☞ page 56)
	Displays the sound adjustment screen. (☞ page 39)
TP	Activates/deactivates TA standby reception mode. (☞ page 16)

<HOME> screen

Displays the source control screen/settings screen and changes the picture source.

☞ page 12

Displays the phone control screen*2



<Settings> screen

Changes the detailed settings. (☞ page 46)

Changes the page



Select an item to display on the screen.

AV	Displays the source control screen. (☞ above)
Camera	Displays the picture from the rear view camera. (☞ page 45)
Apps *1	Displays the screen of App from connected iPod touch/iPhone. (☞ page 30)
Off	Turns off the screen. (☞ page 9)

*1 Appears when <Input> in <Navigation Input> is set to [iPhone]. (☞ page 30)

*2 Only for KW-ADV65BT/KW-AV61BT.

*3 The icon varies depending on the connection status of the Bluetooth device (☞ page 51).

- Press [] to return to the previous screen.
- Press [] to display the current source control screen.

AV SOURCE OPERATIONS

Selecting the playback source

KW-ADV65BT/KW-AV61BT Region 1



KW-AV61 Region 1



KW-AV61BT Region 4



KW-AV61 Region 4



- Pressing SRC on the monitor panel repeatedly also selects the playback source.

TUNER (☞ page 13)	Switches to the radio broadcast.
Satellite *1 (☞ page 35)	Switches to the SiriusXM™ radio broadcast.
DISC (☞ page 17)	Plays a disc.
USB (☞ page 24)	Plays files on a USB device.
iPod (☞ page 26)	Plays an iPod/iPhone.
Pandora *1 (☞ page 32)	Switches to the Pandora.
Bluetooth *2 (KW-ADV65BT/KW-AV61BT: ☞ page 60/KW-AV61: ☞ page 61)	<ul style="list-style-type: none"> KW-ADV65BT/KW-AV61BT: Plays a Bluetooth audio player. KW-AV61: Selects a Bluetooth device.
AV-IN *3 (☞ page 34)	Switches to an external component connected to LINE IN/VIDEO IN jacks on the rear panel.
Apps *4 (☞ page 30)	Switches to the screen of App from the connected iPod touch/iPhone.
Front AUX (☞ page 34)	Switches to an external component connected to AUX input terminal on the monitor panel.
AV Off (☞ page 10)	Turns off the AV source.

*1 Only for KW-ADV65BT/KW-AV61BT Region 1/KW-AV61 Region 1.

*2 For KW-AV61: Appears only when <AV Input> is set to [BT]. (☞ page 47)

*3 Appears only when <AV Input> is set to [AV-IN]. (☞ page 47)

*4 Appears only when <AV Input> is set to [iPod]. (☞ page 26)

Listening to the radio

Preparation: Select the appropriate tuner channel interval for <Area Setting>. (☞ page 15)

The screenshot shows the tuner interface with the following labels and descriptions:

- DX/LO indicator:** Points to the DX indicator on the top status bar.
- ST/MO indicator:** Points to the ST indicator on the top status bar.
- Standby reception indicator:** Points to the TP indicator on the top status bar.
- Preset no.:** Points to the 'P1' label next to the frequency.
- Band:** Points to the 'FM1' label.
- PTY Name:** Points to the 'PTY Name' label.
- Station frequency:** Points to '87.9 MHz'.
- Station name/PS:** Points to '10:28'.
- PTY code for FM RBDS:** Points to the 'PTY' icon.
- Preset list:** Points to the grid of preset buttons (P1-P6).
- TP:** Points to the TP button, with a reference to page 16.
- Mode:** Points to the Mode button.
- PTV search:** Points to the PTY search button.
- Navigation:** Points to the HOME, back, forward, and BAND buttons.

The following table lists the controls and their functions:

[P1] – [P6]	<ul style="list-style-type: none"> Selects a stored station. (Press) Stores the current station. (Hold) 	[BAND]	Selects the band. → FM1 → FM2 → FM3 → AM →
[TP]*	Activates/deactivates TA standby reception mode. (☞ page 16)	[◀▶]	Searches for a station. <ul style="list-style-type: none"> Auto search (Press) Manual search (Hold)
[▶]	Displays/hides the information on the current station (☞ below).	[<] [>]	Selects a stored station.
[PTY 🔍]*	Enters PTY search mode. (☞ page 16)	[Mode]	Changes the settings for tuner reception. (☞ pages 14 – 15)
		[HOME]	Displays the <HOME> screen.

* Appears only when FM is selected as the source.

Displaying the information on the current station

The first screenshot shows the tuner interface with the TP button highlighted by a hand icon. The second screenshot shows the same interface with a pop-up window displaying station information: Song Title, Artist Name, and Album Name. A hand icon is shown scrolling through this information.

Hides the text information: Pressing the TP button.

Text information (only for Radio Text Plus): The pop-up window showing Song Title, Artist Name, and Album Name.

Scrolls the text information: Touching and moving the pop-up window.

When an FM stereo broadcast is hard to receive...

Activate monaural mode for better reception.

1



2

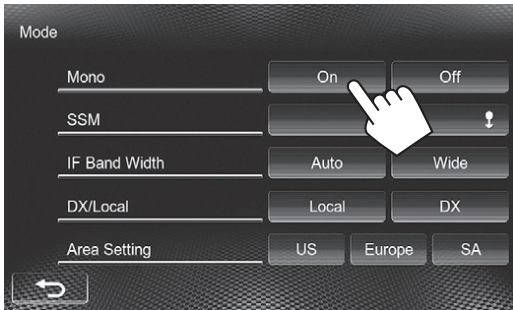

On	Activate monaural mode to improve FM reception, but the stereo effect will be lost. The MO indicator lights up.
Off	Restore the stereo effect.

When the FM reception is interfered...

1



2

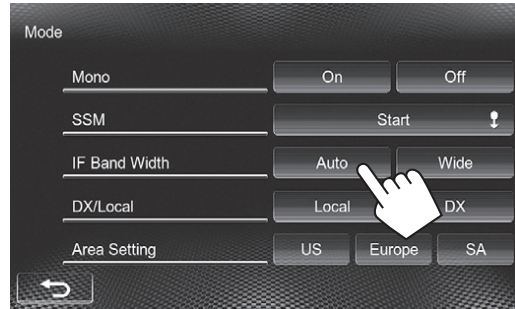

Auto	Increases the tuner selectivity to reduce interference noises between adjacent stations. (Stereo effect may be lost.)
Wide	Subject to the interference from adjacent stations, but sound quality will not be degraded and the stereo effect will remain.

Tuning in FM stations only with strong signals—LO/DX (Local/Distance-extreme)

1



2

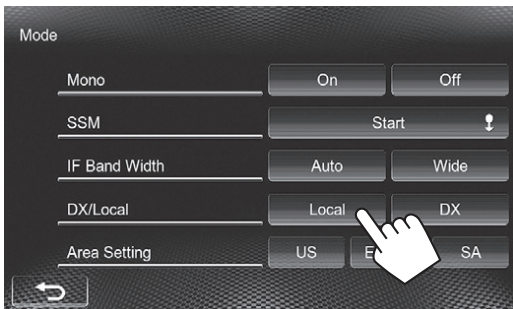

Local	Select this to tune in only to stations with sufficient signal strength. The LO indicator lights up.
DX	Deactivate the function. The DX indicator lights up.

■ Changing the tuner channel interval

Tuner channel interval changes depending on the area you use this unit.

1



2

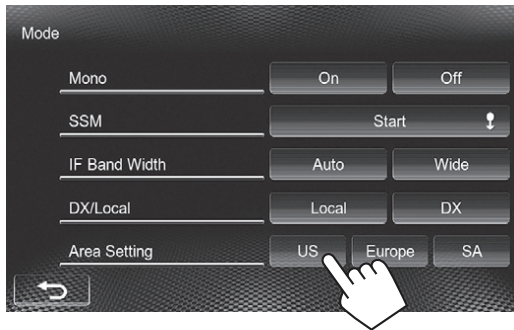

US	Select this when using in North/Central/South America. FM/AM intervals are set to 200 kHz/10 kHz.
Europe	Select this when using in any other areas. FM/AM intervals are set to 50 kHz/9 kHz.
SA	Select this when using in South American countries where FM interval is 50 kHz. AM interval is set to 10 kHz.

- The initial setting is <US> for KW-ADV65BT/ KW-AV61BT Region 1/KW-AV61 Region 1, and <SA> for KW-AV61BT Region 4/KW-AV61 Region 4.

■ Storing stations in memory

You can preset six stations for each band.

Automatic presetting—SSM (Strong-station Sequential Memory) (For FM only)

1



2



Local stations with the strongest signals are searched and stored automatically.

Manual presetting

- 1 **Tune in to a station you want to preset.**
(🔍 page 13)
- 2 **Select a preset number.**



The station selected in step 1 is stored.

Selecting a preset station

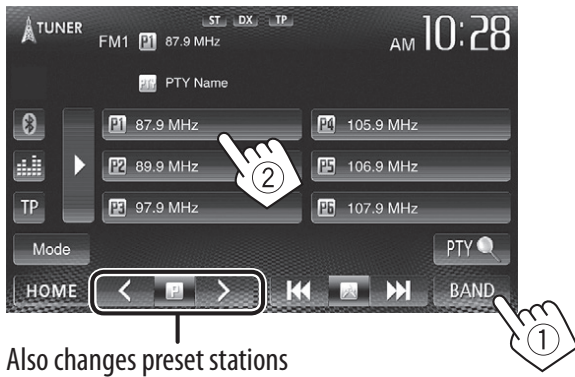

The following features are available only for FM RBDS stations.

Searching for FM RBDS program—PTY Search

You can search for your favorite programs being broadcast by selecting the PTY code for your favorite programs.

1

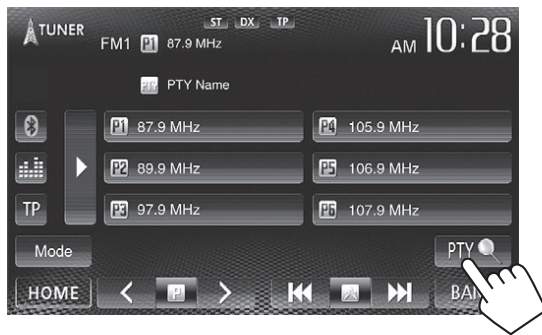

2 Select a PTY code.

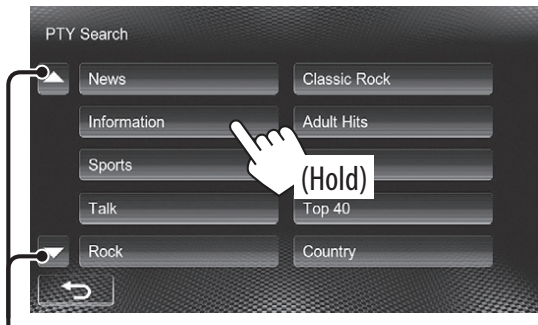

Changes the page

PTY Search starts.

If there is a station broadcasting a program of the same PTY code as you have selected, that station is tuned in.

Activating/deactivating TA Standby Reception

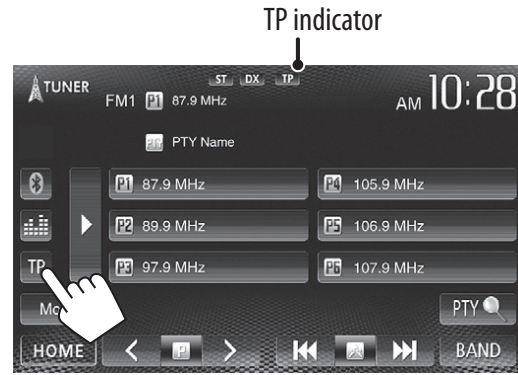

TP indicator	TA Standby Reception
Lights up	The unit will temporarily switch to Traffic Announcement (TA) if available.
Flashes	Not yet activated. Tune in to another station providing the RBDS signals.
Goes off	Deactivated.

- The volume adjustment for Traffic Announcement is automatically memorized. The next time the unit switches to Traffic Announcement, the volume is set to the previous level.

Disc operations

Playing a disc

- If a disc does not have any disc menu, all tracks on it will be played repeatedly until you change the source or eject the disc.

■ Inserting a disc

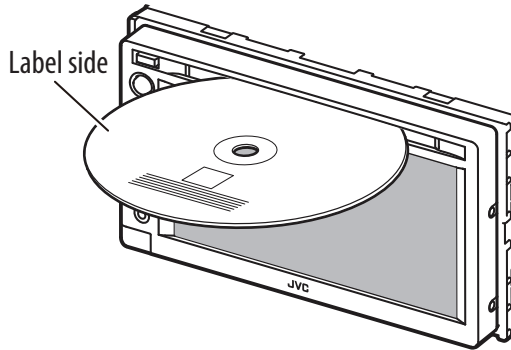

The source changes to "DISC" and playback starts.

- The DISC IN (DISC IN) indicator lights up while a disc is inserted.

- If "⊘" appears on the screen, the unit cannot accept the operation you have tried to do.
 - In some cases, without showing "⊘," operations will not be accepted.
- When playing back a multi-channel encoded disc, the multi-channel signals are downmixed to stereo.

■ Ejecting a disc

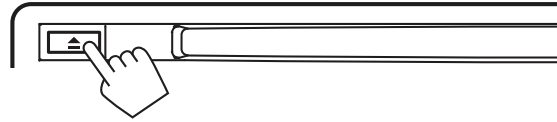

- You can eject a disc when playing another AV source.
- If the ejected disc is not removed within 15 seconds, the disc is automatically inserted again into the loading slot to protect it from dust.
- If the disc cannot be ejected, see page 3.

When removing a disc, pull it horizontally.

■ Prohibiting disc ejection

Press SRC/⏻ and ▲ on the monitor panel at the same time.

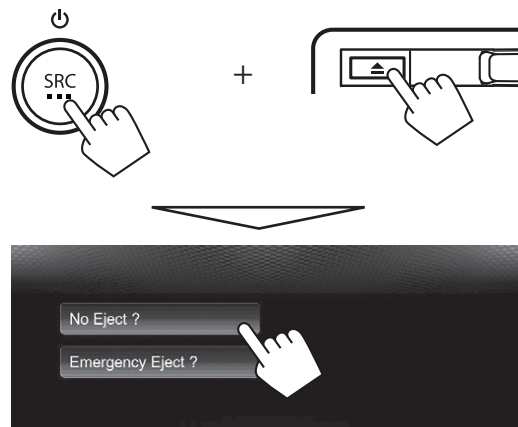

To cancel the prohibition, repeat the same procedure to select [Eject OK?].

Playable disc types

Disc type	Recording format, file type, etc.	Playable								
DVD • DTS sound cannot be reproduced or emitted from this unit.	DVD-Video * ¹ Region Code: <table border="1" style="display: inline-table; vertical-align: middle;"> <tr> <td>ALL</td> <td>1</td> <td>1 2</td> <td>1 2 3 4</td> </tr> <tr> <td>ALL</td> <td>4</td> <td>3 4</td> <td>1 2 3 4</td> </tr> </table> <ul style="list-style-type: none"> • KW-ADV65BT: 1 • KW-AV61BT/KW-AV61: 1/4 (depending on the country and sales area) 	ALL	1	1 2	1 2 3 4	ALL	4	3 4	1 2 3 4	✓OK
	ALL	1	1 2	1 2 3 4						
ALL	4	3 4	1 2 3 4							
DVD-Audio/DVD-ROM		✗NO								
DVD Recordable/Rewritable (DVD-R/-RW *², +R/+RW *³) • DVD Video: UDF bridge • DVD-VR • DivX * ⁴ /MPEG1/MPEG2/JPEG/MP3/WMA/WAV: ISO 9660 level 1, level 2, Romeo, Joliet	DVD-Video	✓OK								
	DVD-VR * ⁵									
	DivX * ⁴ /MPEG1/MPEG2									
	JPEG									
	MP3/WMA/WAV									
	MPEG4/AAC/DVD+VR/DVD-RAM	✗NO								
Dual Disc	DVD side	✓OK								
	Non-DVD side	✗NO								
CD/VCD	Audio CD/CD Text (CD-DA)	✓OK								
	VCD (Video CD)									
	DTS-CD/SVCD (Super Video CD)/CD-ROM/CD-I (CD-I Ready)	✗NO								
CD Recordable/Rewritable (CD-R/-RW) • ISO 9660 level 1, level 2, Romeo, Joliet	CD-DA	✓OK								
	VCD (Video CD)									
	DivX * ⁴ /MPEG1/MPEG2									
	JPEG									
	MP3/WMA/WAV									
	MPEG4/AAC	✗NO								

*¹ If you insert a DVD Video disc of an incorrect Region Code, "Region Code Error" appears on the screen.

*² DVD-R recorded in multi-border format is also playable (except for dual layer discs). DVD-RW dual layer discs are not playable.

*³ It is possible to play back finalized +R/+RW (Video format only) discs. "DVD" is selected as its disc type when a +R/+RW disc is loaded. +RW double layer discs are not playable.

*⁴ Playable only for KW-ADV65BT/KW-AV61BT Region 1/KW-AV61 Region 1.

*⁵ This unit cannot play back contents protected with CPRM (Content Protection for Recordable Media).

Caution for DualDisc playback

The Non-DVD side of a "DualDisc" does not comply with the "Compact Disc Digital Audio" standard. Therefore, the use of Non-DVD side of a DualDisc on this product may not be recommended.

Playback operations

- When the operation buttons are not displayed on the screen, touch the area shown on the illustration.

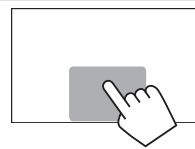

ENGLISH

For DVD/DVD-VR/VCD/DivX/MPEG1/MPEG2/JPEG

Labels in the screenshot:

- Audio format: DVD
- Media type: VIDEO
- Playback mode: CHAPTER 01
- Playing time: 00:01:20
- DISC IN indicator
- Video format/video playback mode—VIDEO/VR-PRG (program)/VR-PLAY (playlist)/DivX/MPEG/PBC
- Playback status: play/pause/stop icons

Playback status details:

- DVD Video: Title no./Chapter no.
- DVD-VR: Program no. (or Playlist no.)/Chapter no.*1
- DivX/MPEG1/MPEG2: Folder no./Track no.
- JPEG: Folder no./File no.
- VCD: Track no.

- | | | | |
|---------------|---|--------------|---|
| [■]*2 | Stops playback. | [◀◀] [▶▶]*5 | • Selects a chapter/track. (Press) |
| [🔍]*3 | Displays the folder/track list. (☞ page 20) | [<] [>]*5 *7 | • Reverse/forward search.*6 (Hold) |
| [↺] [↕] [↗]*4 | Selects playback mode. (☞ page 22) | [Mode]*7 | • Selects title (DVD)/program or playlist (DVD-VR)/folder (DivX/MPEG1/MPEG2/JPEG). *1 |
| [▶/] | Starts/pauses playback. | [HOME] | Changes the settings for disc playback. (☞ page 23) |
| | | | Displays the <HOME> screen. |

*1 To display the Original Program/Playlist screen, ☞ page 21.

*2 Appears only for DVD/DVD-VR/VCD.

*3 Does not appear for DVD/DVD-VR/VCD.

*4 Does not appear for DVD/DVD-VR/JPEG.

*5 The icon displayed between the buttons varies depending on the type of disc or file.

*6 Search speed varies depending on the type of disc or file.

*7 Does not appear for VCD.

For CD/MP3/WMA/WAV

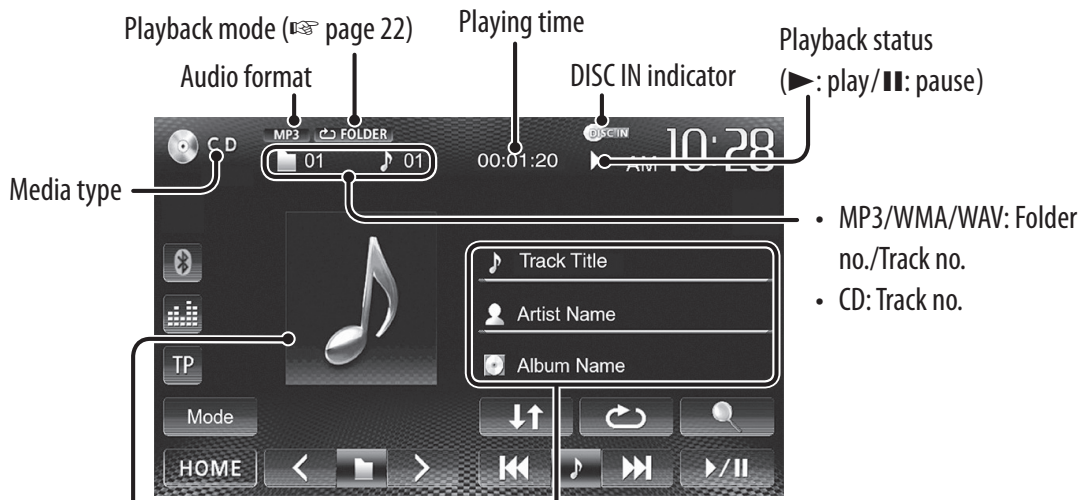

While playing, the jacket picture is shown if the file has the tag data including the jacket picture.

Track/file information

- Touching the information bar scrolls the text if not all of the text is shown.

[🔍]*1 Displays the folder/track list. (👉 below)

[↺][↕][↗] Selects playback mode. (👉 page 22)

[▶/⏸] Starts/pauses playback.

[◀◀] [▶▶] • Selects a track. (Press)
• Reverse/forward search.*2 (Hold)

[<] [>]*1 Selects a folder.

[Mode]*1 Changes the settings for disc playback. (👉 page 23)

[HOME] Displays the <HOME> screen.

*1 Does not appear for CD.

*2 Search speed varies depending on the type of disc or file.

Selecting a folder/track on the list

Changes the page

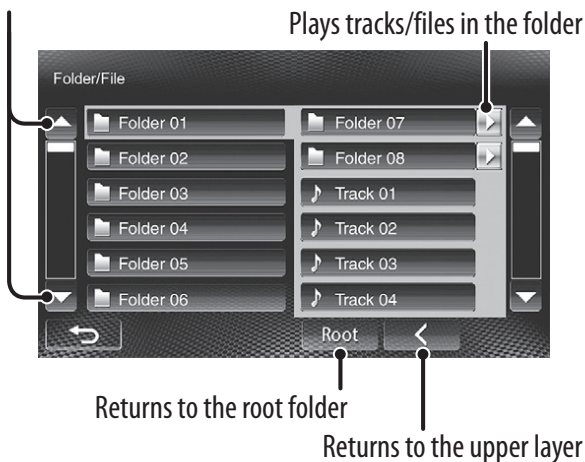

Playing Recordable/Rewritable discs

- This unit can recognize a total of 5 000 files and 250 folders (a maximum of 999 files per folder).
- Use only “finalized” discs.
- This unit can play back multi-session discs; however, unclosed sessions will be skipped while playing.
- Some discs or files may not be played back due to their characteristics or recording conditions.

Video menu operations

You can display the video menu screen during video playback.

- Available items on the screen differ depending on the types of the loaded disc and playback files.
- The operation buttons disappear by touching the screen or when no operation is done for about 10 seconds.

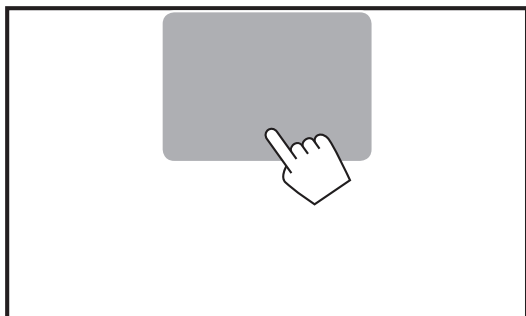

- The screen for MPEG1/MPEG2 differs from the above.



- [Zoom]** Displays the picture size selecting screen. (☞ page 44)
- [Aspect]** Selects the aspect ratio. (☞ page 44)
- [Adjust]** Displays the picture adjustment screen. (☞ page 43)
- []** Selects the audio type.
 - For DVD-VR: Selects the audio channel (ST: stereo, L: left, R: right).
- []** Selects the subtitle type.
- []** Selects the view angle.
- [Menu]** Displays the disc menu (DVD)/playlist (DVD-VR).

[Top Menu] Displays the disc menu (DVD)/original program (DVD-VR).

[] Displays the menu/playlist/original program/scene selecting screen. (☞ below)

[] Switches to the direct disc menu mode. Touch the target item to select.

- To exit from the menu selecting screen, press [↩].

- Touching any position other than operation buttons displays the source control screen.

Using the menu/playlist/original program/scene selecting screen



[▲] [▼]
[◀] [▶] Selects an item.

[Enter] Confirms the selection.

[Return] Returns to the menu screen of the previous layer.

[↩] Displays the menu screen of the top layer when several menu screens exist on the disc.

- For DivX only

[◀] [▶] Skips back or forward by about 5 minutes.

[Enter] Confirms the selection.

[↩] Exits from the scene selecting screen.

- For DVD-VR only

[▲] [▼] Selects an item.

[Enter] Confirms the selection.

[↩] Displays the menu screen of the top layer when several menu screens exist on the disc.

Only for VCD

1



2

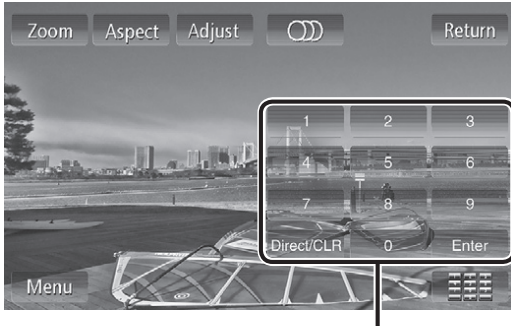

Direct selecting buttons (➡ below)

- [Zoom]** Displays the picture size selecting screen. (➡ page 44)
- [Aspect]** Selects the aspect ratio. (➡ page 44)
- [Adjust]** Displays the picture adjustment screen. (➡ page 43)
- []** Selects the audio channel (ST: stereo, L: left, R: right).
- [Return]** Displays the previous screen or the menu.
- [Menu]** Displays the disc menu.
- []** Displays/hides the direct selecting buttons. (➡ below)

- To select a track directly



– When you enter a wrong number, press **[Direct/CLR]** to delete the last entry.

- To deactivate the PBC function, press **[]** then the direct selecting buttons to select a track number.

Selecting playback mode

For DVD/DVD-VR



Selects Repeat playback mode

For VCD (without PBC)/CD/DivX/MPEG1/MPEG2/MP3/WMA/WAV



Selects Random playback mode*

Selects Repeat playback mode*

* You cannot activate the repeat mode and the random mode at the same time.

- Each time you press the button, the playback mode changes. (The corresponding indicator lights up.)
 - Available items differ depending on the types of loaded disc and playback file.

Indicator	Playback mode
CHAPTER	Repeats current chapter.
TITLE	Repeats current title.
PROGRAM	Repeats current program (not available for Playlist playback).
SONGS	Repeats current track.
FOLDER	Repeats all tracks of the current folder.
FOLDER	Randomly plays all tracks of current folder, then tracks of next folders.
ALL	Randomly plays all tracks.

To cancel, press the button repeatedly until the indicator disappears.

Settings for disc playback



Disc Setup items	Selectable setting/item	Initial: <u>Underlined</u>
For DVD/DVD-VR	Menu Language	Select the initial disc menu language; Initial <u>English</u> (☞ page 67).
	Audio Language	Select the initial audio language; Initial <u>English</u> (☞ page 67).
	Subtitle	Select the initial subtitle language or erase the subtitle (Off). • Initial for KW-ADV65BT/KW-AV61BT Region 1/KW-AV61 Region 1: <u>Off</u> , for KW-AV61BT Region 4/KW-AV61 Region 4: <u>English</u> (☞ page 67)
	Down Mix	When playing back a multi-channel disc, this setting affects the signals reproduced through the FRONT OUT/REAR OUT jacks. ◆ Dolby Surround : Select this to enjoy multi-channel surround audio by connecting an amplifier compatible with Dolby Surround. ◆ <u>Stereo</u> : Normally select this.
	D. (Dynamic) Range Compres. (Compression)	You can change the dynamic range while playing Dolby Digital software. ◆ Off : Select this to enjoy a powerful sound at a low volume level with its full dynamic range. ◆ <u>On</u> : Select this to reduce the dynamic range a little. ◆ Dialog : Select this to reproduce the movie dialog more clearly.
For discs except VCD/CD	Monitor Type	Select the monitor type to watch a wide screen picture on the external monitor. ◆ <u>16:9</u> ◆ 4:3 LB (Letterbox) ◆ 4:3 PS (PanScan) 
For discs containing audio/video/picture files	File Type	Select the playback file type when a disc contains different types of files. ◆ Audio : Plays back audio files. ◆ Still Picture : Plays back JPEG files. ◆ Video : Plays back DivX/MPEG1/MPEG2 files. ◆ <u>Audio&Video</u> : Plays back audio files and DivX/MPEG1/MPEG2 files. • For playable file types, ☞ page 18. • If the disc contains no files of the selected type, the existing files are played in the following priority: audio, video, then still picture.

Playing a USB device

- This unit can play JPEG/MPEG1/MPEG2*/MP3/WMA/WAV files stored in a USB mass storage class device.
- This unit can recognize a total of 5 000 files and 250 folders (a maximum of 999 files per folder).
- Make sure all important data has been backed up to avoid losing the data.

* Except for MPEG2 files recorded by JVC Everio camcorder (extension code <.mod>).

■ Connecting a USB device

You can connect a USB mass storage class device such as a USB memory, Digital Audio Player etc. to the unit.

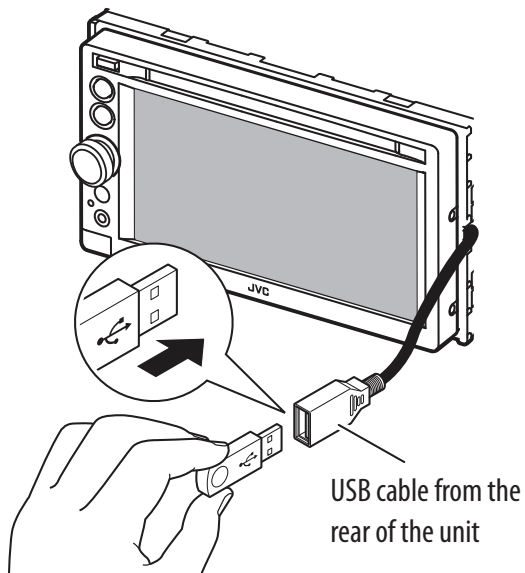

The source changes to “USB” and playback starts.

- All tracks in the USB device will be played repeatedly until you change the source.

Cautions:

- This unit may not play back files in a USB device properly when using a USB extension cable.
- USB devices equipped with special functions such as data security functions cannot be used with the unit.
- Do not use a USB device with 2 or more partitions.
- Depending on the shape of the USB devices and connection ports, some USB devices may not be attached properly or the connection might be loose.
- This unit cannot recognize a USB device whose rating is other than 5 V and exceeds 1 A.
- This unit may not recognize a memory card inserted into the USB card reader.
- Connect only one USB device to the unit at a time. Do not use a USB hub.
- When connecting with a USB cable, use the USB 2.0 cable.
- The maximum number of characters (when the characters are 1 byte):
 - Folder names: 50 characters
 - File names: 50 characters
- Avoid using the USB device if it might effect driving safety.
- Do not pull out and connect the USB device repeatedly while “Now Reading” is shown on the screen.
- Electrostatic shock at connecting a USB device may cause abnormal playback of the device. In this case, disconnect the USB device then reset this unit and the USB device.
- Operation and power supply may not work as intended for some USB devices.
- Do not leave a USB device in the car, or expose to direct sunlight or high temperature to avoid deformation or damage to the device.

- When the operation buttons are not displayed on the screen, touch the area shown on the illustration.
- To change settings for video playback,  page 43.

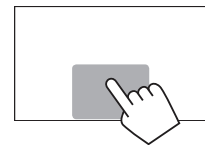
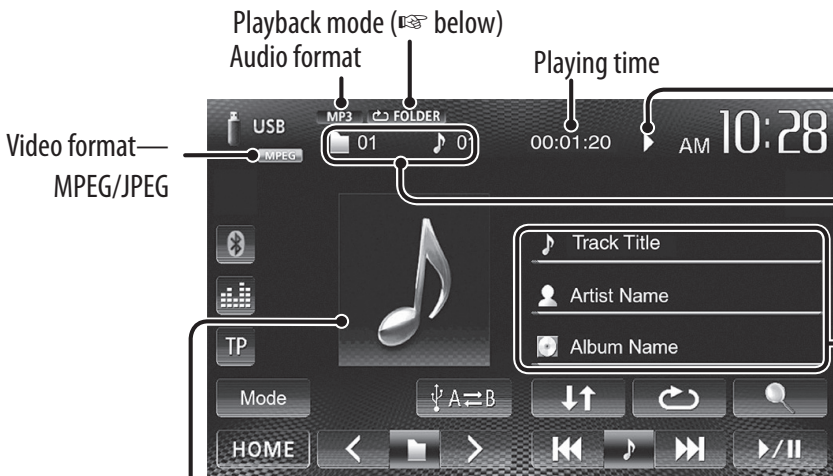
Playback mode ( below)

Audio format

Video format— MPEG/JPEG

USB

MP3

FOLDER

Playing time 00:01:20

Playback status (▶: play/⏸: pause)

Track Title

Artist Name

Album Name

TP

Mode

A=B

HOME

- MPEG1/MPEG2/MP3/WMA/WAV: Folder no./Track no.
- JPEG: Folder no./File no.



Track/file information (for MP3/WMA/WAV)

- Touching the information bar scrolls the text if not all of the text is shown.



Only for MP3/WMA/WAV: While playing, the jacket picture is shown if the file has the tag data including the jacket picture.

[🔍] Displays the folder/track list. ( page 20)

[🔄] Selects repeat playback mode. *1 *2

-  **SONGS**: Repeats the current track.
-  **FOLDER**: Repeats all tracks in the current folder.

[↕] Selects random playback mode. *1 *2

-  **FOLDER**: Randomly plays all tracks in the folder.
-  **ALL**: Randomly plays all tracks.

[🔌 A ↔ B] Switches between the internal and external memory source of the connected device (such as mobile phone).

[▶/⏸] Starts/pauses playback.

[◀◀][▶▶]*3

- Selects a track. (Press)
- Reverse/forward search.*4 (Hold)

[<][>] Selects a folder.

[Mode] Changes the settings for <File Type> and <Monitor Type>. ( below)

[HOME] Displays the <HOME> screen.

- Available items differ depending on the types of playback file.

*1 To cancel random or repeat mode, press the button repeatedly until the indicator disappears.

*2 You cannot activate the repeat mode and the random mode at the same time.

*3 The icon displayed between the buttons varies depending on the file type.

*4 Search speed varies depending on the file type.



Setting <File Type>

Audio	Plays back audio files.
Still Picture	Plays back JPEG files.
Video	Plays back MPEG1/MPEG2 files.
Audio&Video	Plays back audio files and MPEG1/MPEG2 files.



- If the USB device contains no files of the selected type, the existing files are played in the following priority: audio, video, then still picture.

Setting <Monitor Type>

Select the monitor type to watch a wide screen picture on the external monitor.

16:9	4:3 LB (Letterbox)	4:3 PS (PanScan)
		

Listening to the iPod/iPhone device

- To use App of iPod touch/iPhone (such as MotionX-GPS Drive),  page 30.
- To listen to Pandora,  page 32.

Preparation

iPod/iPhone that can be connected to this unit:

Made for

- iPod with video
- iPod classic
- iPod nano (6th Generation)
- iPod nano (5th Generation)
- iPod nano (4th Generation)
- iPod nano (3rd Generation)
- iPod touch (4th Generation)
- iPod touch (3rd Generation)
- iPod touch (2nd Generation)
- iPod touch (1st Generation)
- iPhone 4S
- iPhone 4
- iPhone 3GS
- iPhone 3G
- iPhone

Connecting iPod/iPhone

Connect your iPod/iPhone using the appropriate cable according to your purpose.

- **To listen to music:** USB 2.0 cable (accessory of the iPod/iPhone)

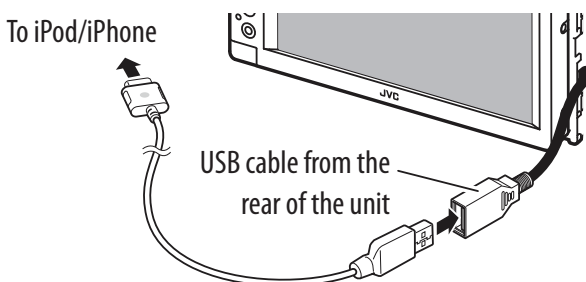

- **To watch video and listen to music:** USB Audio and Video cable for iPod/iPhone—KS-U30 (separately purchased) ( Installation/Connection Manual)

Caution:

- Video is not displayed on the screen if connected with any cable other than KS-U30.

Setting <AV Input> for iPod/iPhone playback

Select an appropriate input setting for <AV Input> according to the connection method of the iPod/iPhone.

1 Turn off the AV source.

On <HOME> screen:

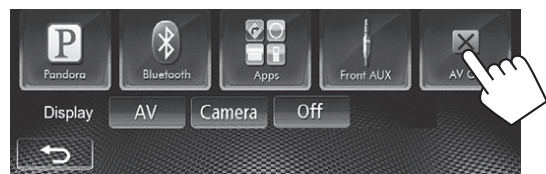

2 Display the <Input> screen.

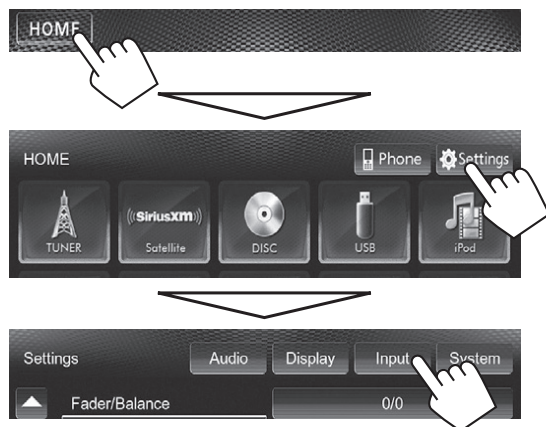

3



AV-IN	Select this when the iPod/iPhone is connected using the USB 2.0 cable (accessory of the iPod/iPhone).
--------------	---

iPod	Select this when the iPod/iPhone is connected using KS-U30 (separately purchased).
-------------	--

Setting iPod control mode

Select the unit controlling iPod/iPhone playback.

When the source is "iPod"...

1



2



Head	Controls playback from this unit. (☞ page 28)
iPod	Controls audio/video playback from the iPod/iPhone. • Playback information is shown.
iPod Out*	Displays the menu and playback screen output from iPod/iPhone. (☞ page 29) • You can control playback from this unit in the same way as on the iPod/iPhone.

- When using iPod with video with [iPod] selected for <iPod Control>, select [iPod] for <AV Input> and connect iPod using KS-U30 (separately purchased). (☞ page 26)

* <iPod Out> is available when <AV Input> is set to [iPod] (☞ page 26) only for the following iPod/iPhone models:

- iPod nano (6th Generation)
- iPod touch (4th Generation)
- iPod touch (3rd Generation)
- iPod touch (2nd Generation)
- iPhone 4S
- iPhone 4
- iPhone 3GS
- iPhone 3G

Selecting preference settings for iPod/iPhone playback

When the source is "iPod"...

1



2

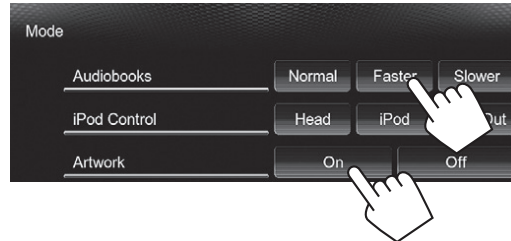

Audiobooks	Select the speed of audio books.
Artwork	Shows/hides the iPod artwork.

- You can change the settings when <iPod Control> is set to [Head].

Notice:



When operating an iPod/iPhone, some operations may not be performed correctly or as intended. In this case, visit the following JVC web site: <<http://www3.jvckenwood.com/english/car/>> (English website only)

For some iPod/iPhone models, the performance may be abnormal or unstable during operation. In this case, disconnect the iPod/iPhone device, then check its condition.
If the performance is not improved or slow, reset your iPod/iPhone.

iPod/iPhone playback operations for <Head> mode

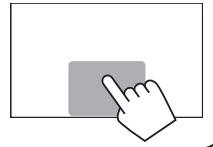
- When the operation buttons are not displayed on the screen, touch the area shown on the illustration.
- To change settings for video playback,  page 43.



- Select “**iPod**” as the source. ( page 12)
- Make sure to select [**Head**] for <iPod Control>. ( page 27)
- When you turn on this unit, the iPod/iPhone is charged through the unit.





Track no./Total track number/
Playing time Playback mode ( below)

iPod control mode
( page 27)

Playback status
(▶: play/||: pause)

Song/video information
• Touching the information bar scrolls the text if not all of the text is shown.

While playing, Artwork (the picture displayed on the screen of iPod/iPhone) is shown if the song contains the Artwork ( page 27).

[🔍]	Displays the audio/video file list. ( page 29)	[▶/]	Starts/pauses playback.
[↺]	Selects Repeat playback mode.* ¹ •  SONGS : Functions the same as “Repeat One.”	[◀◀] [▶▶]	• Selects an audio/video file.* ² (Press) • Reverse/forward search. (Hold)
[↕]	Selects Random playback mode.* ¹ •  SONGS : Functions the same as “Shuffle Songs.” •  ALBUMS : Functions the same as “Shuffle Albums.”	[Mode]	Changes the settings for iPod playback. ( page 27)
		[HOME]	Displays the <HOME> screen.

- To watch the video, select an item on the list of the Video menu. ( page 29)

*¹ To cancel random and repeat mode, press the button repeatedly until the indicator disappears.

*² Resume playback is unavailable for video files.

When you use an App of the connected iPod touch/iPhone, <iPod Control> may be set to [iPod] unintentionally. To change the setting,  page 27.

■ Selecting an audio/video file from the menu

1



2 Select the menu (audio or video) (①), a category (②), then a desired item (③).

- Select the item in the selected layer until a desired file starts playing.

Audio menu:

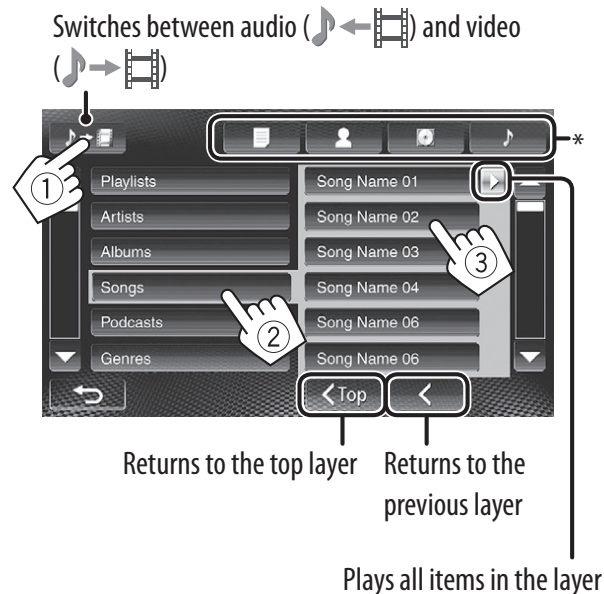

Video menu:

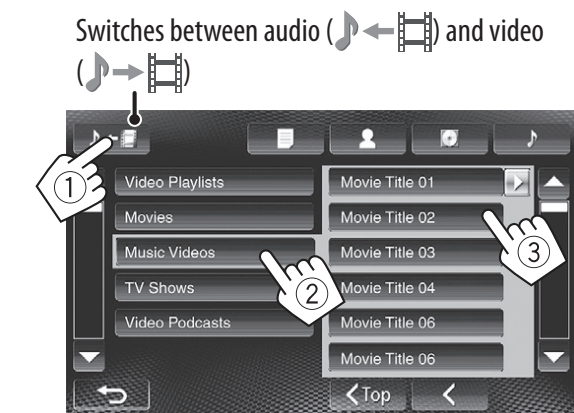

- Available categories differ depending on the type of your iPod/iPhone.

* You can switch to the top of the category by pressing the corresponding tab: Playlist (📄), Artist (👤), Albums (🎵) or Songs (🎵).

iPod/iPhone playback operations for <iPod Out> mode

- Connect the iPod/iPhone using KS-U30 (separately purchased). (👉 Installation/Connection Manual)
- Select [iPod] for <AV Input>. (👉 page 26)
- Make sure to select [iPod Out] for <iPod Control>. (👉 page 27)
- Select "iPod" as the source. (👉 page 12)

■ Selecting a track from the menu on the iPod/iPhone

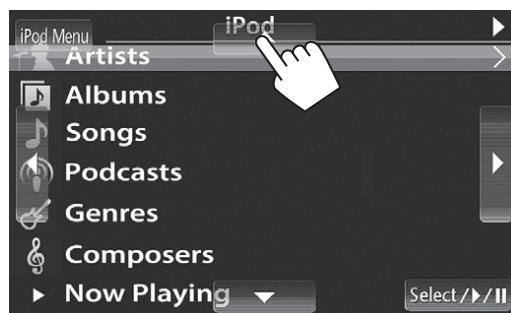

- [▲][▼] Selects a category.
- [Select/▶/||] Confirms the selection.
- [iPod Menu] Returns to the previous layer.

■ Operations during playback



- [◀][▶] Skips to the previous/next track.
- [Select/▶/||] Starts/pauses playback.
- [iPod Menu] Displays the menu.

Using an App of iPod touch/iPhone

You can use an App of the connected iPod touch/iPhone on this unit.

- You can operate some functions of an App on the touch panel.

Preparation

- Connect the iPod touch/iPhone using KS-U30 (separately purchased). (☞ Installation/Connection Manual)
- Select [iPod] for <AV Input>. (☞ page 26)
- For Apps you can use on this unit, visit <<http://mobile.jvc.com>>.

1 Start App on your iPod touch/iPhone.

2 Select "Apps" as the source.

On <HOME> screen:



You can operate for basic playback on the touch panel.

Audio

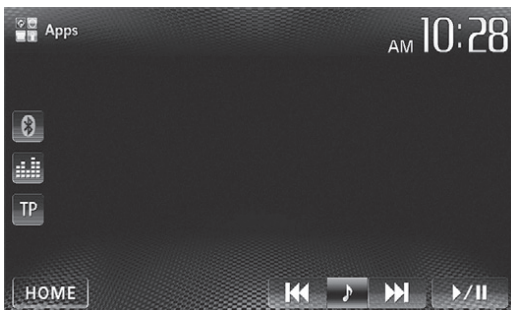

Video



- For some applications such as MotionX-GPS Drive, the operating buttons and information are not shown. You can perform the operations on the touch panel, such as scrolling the map.
- You can also play back the audio/video using iPod/iPhone itself instead of the unit.

- When you use an App of the iPod touch or iPhone, see also page 31 for safety instructions.

■ Displaying the screen of App while listening to another source

You can switch to the screen of App (such as MotionX-GPS Drive) from the connected iPod touch/iPhone while listening to another source.

Displaying the Apps switch button on the source control screen and <HOME> screen

- Select [AV] for <Display> on the <HOME> screen beforehand. (☞ page 11)

1 Turn off the AV source.

On <HOME> screen:

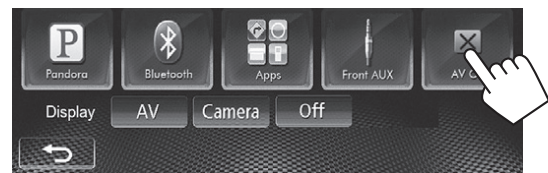

2 Display the <Input> screen.

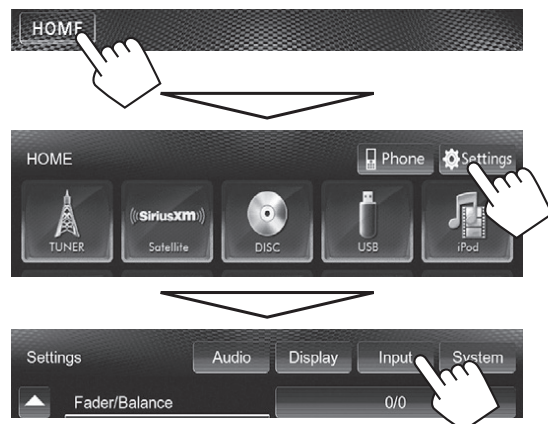

3 Select [iPhone] for <Input> on the <Navigation Input> screen.

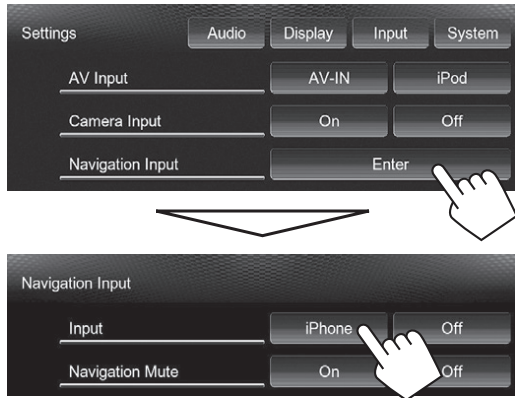

- When <Input> is set to [iPhone], the [Apps] button is shown on the <HOME> screen, and the [] button is shown on the source control screen. You can display the screen of App by pressing either button. (☞ the right column)
- When <Input> is set to [iPhone], the <AV Input> setting is automatically changed and fixed to [iPod].

To deactivate, select [Off] for <Input>.

To view the screen of App

On <HOME> screen:

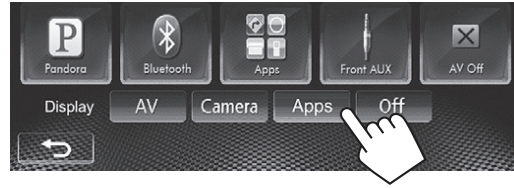

or

On source control screen:

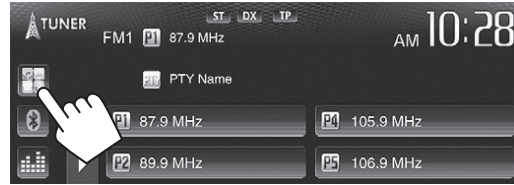

To erase the screen of App

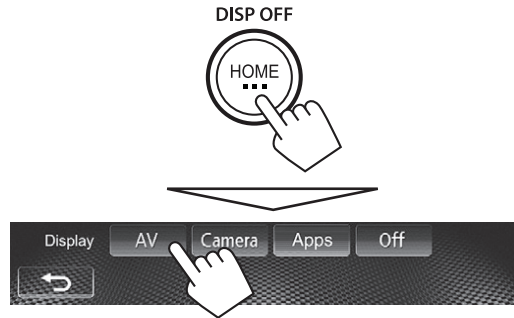

SAFETY INSTRUCTIONS

Use of the iPhone Navigation App is only permitted if the traffic conditions are suitable and you are absolutely sure that no risk, obstruction or injury will be incurred to you, your passengers or other road users. The requirements of the Road Traffic Regulations must always be followed and may vary by state. The destination must not be entered while the vehicle is in motion.

iPhone Navigation guidance may not be applicable to the current situation because of changes in traffic conditions (e.g. changes in tollroads, principal roads, one-way traffic, or other traffic regulations). In this case, observe the current traffic signs or regulations.

- Traffic signs should be observed carefully while driving using the iPhone Navigation App. iPhone Navigation App is only an aid. Driver must always decide whether or not to heed the information provided. **We do not accept liability for erroneous data provided by the iPhone Navigation App.**
- **Do not operate the unit while driving.**

Preparation

Install the latest version of the Pandora application on your iPhone/iPod touch/Android/BlackBerry.

- You can operate Pandora using the remote controller. Only playing, pausing, and skipping are available.

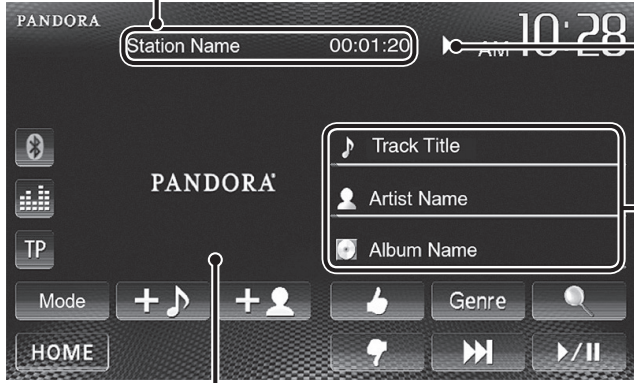

Station name/Playing time

Playback status (▶: play/||: pause)

Track information

- Touching the information bar scrolls the text if not all of the text is shown.

The picture data is displayed if available from the current content and when iPhone/iPod touch is connected via USB.

[🔍]	Displays the <Station List>. (☞ page 33)	[+🎵]	Adds the current track to the <Station List>.
[Genre]	Displays the <Genre List>. (☞ page 33)	[▶/]	Starts/pauses playback.
[👍]	Registers the current track as favorite.	[▶▶]	Skips the current track. <ul style="list-style-type: none"> Not available when the Pandora skip reaches its limit.
[👎]	Thumbs down to the current track and skips to the next track.	[Mode]	Displays the connection mode switch screen. (☞ below)
[+👤]	Adds the current artist to the <Station List>.	[HOME]	Displays the <HOME> screen.

Selecting the connection method for Pandora

You can stream Pandora from iPhone/iPod touch via a wired connection or from Android or BlackBerry devices through Bluetooth.

- For Bluetooth connection, ☞ page 52.
- For wired connection, ☞ Installation/Connection Manual.

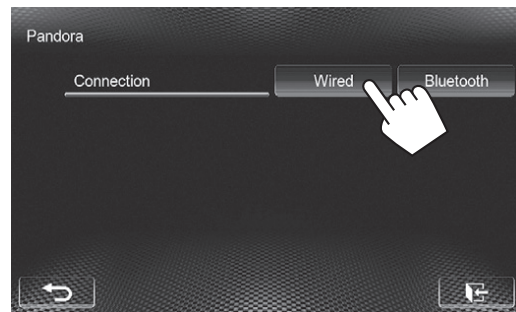

Wired	Select this to connect iPhone/iPod touch via USB.
Bluetooth	Select this to connect Android/BlackBerry via Bluetooth.

Adding a station from the <Genre List> to the <Station list>

The screen shows the genres sent by the connected device. Select a genre and station to add to the Station List.

1 Select a genre.

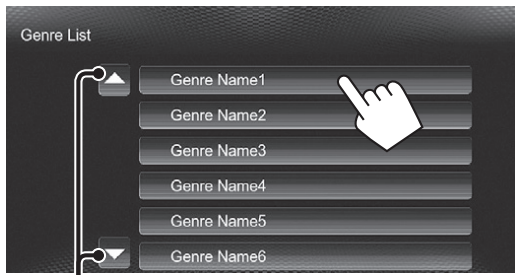

Changes the page

2 Select a station.



Changes the page

The selected station is added to the Station List.

Selecting a station from the <Station List>

Appears when Shuffle is activated (All songs in the registered stations are played randomly)

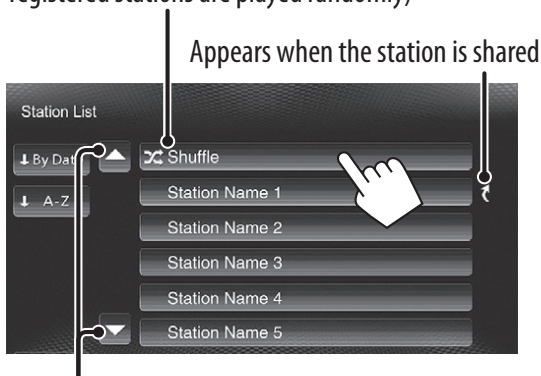

Changes the page

To sort the <Station List>

By Date	Sorts the list in reverse chronological order.
A-Z	Sorts the list in alphabetical order.

Requirements for Pandora®

iPhone or iPod touch

- Use an Apple iPhone or iPod touch running under iOS3 or later.
- Install the latest version of the Pandora application on your iPhone or iPod touch. (Search for “Pandora” in the Apple iTunes App Store to find and install the most current version.)

Android™

- Visit the Google play and search for Pandora to install.
- Bluetooth must be built in and the following profiles must be supported.
 - SPP (Serial Port Profile)
 - A2DP (Advanced Audio Distribution Profile)

BlackBerry®

- Visit www.pandora.com from the built in browser to download the Pandora application.
- Bluetooth must be built in and the following profiles must be supported.
 - SPP (Serial Port Profile)
 - A2DP (Advanced Audio Distribution Profile)

NOTE

- Ensure you are logged in to your smartphone application. If you do not have a Pandora account, you can create one for free from your smartphone or at www.pandora.com.
- Pandora is available only in the U.S./Australia/New Zealand.
- Because Pandora is a third-party service, the specifications are subject to change without prior notice. Accordingly, compatibility may be impaired or some or all of the services may become unavailable.
- Some functions of Pandora cannot be operated from this unit.
- For issues using the application, contact Pandora at pandora-support@pandora.com
- Establish an Internet connection by LTE, 3G, EDGE, or WiFi.

Using other external components

- When the operation buttons are not displayed on the screen, touch the area shown on the illustration.
- To change settings for video playback,  page 43.

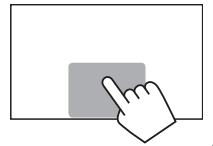

AV-IN name* ( below)

Source type ("AV-IN" or "Front AUX")

AV-IN VIDEO



AM 10:28

TP

* Mode

HOME

[Mode]* Changes the AV-IN name.

- Press [] or [] to select an AV-IN name.

[HOME] Displays the <HOME> screen.

* Appears when "AV-IN" is selected as the source.

Front AUX

1 Connect an external component.

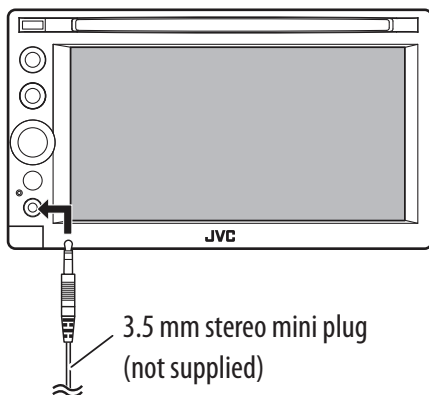

2 Select "Front AUX" as the source.

( page 12)

3 Turn on the connected component and start playing the source.

AV-IN

You can connect external components to the LINE IN/VIDEO IN jacks. ( Installation/Connection Manual)

Preparation:

Select [AV-IN] for <AV Input>. ( page 47)

- <AV Input> can be changed only when <Input> in <Navigation Input> is set to [Off].

1 Select "AV-IN" as the source. (page 12)

2 Turn on the connected component and start playing the source.

Listening to the SiriusXM™ Radio for KW-ADV65BT/KW-AV61BT Region 1/KW-AV61 Region 1

Before operating, connect the SiriusXM Connect Vehicle Tuner (not supplied) to the expansion port on the rear of the unit. (☞ Installation/Connection Manual)

Everything worth listening to is on SiriusXM, getting over 130 channels, including the most commercial-free music, plus the best sports, news, talk and entertainment. To start listening to the SiriusXM™ Satellite Radio, a SiriusXM Connect Vehicle Tuner (separately purchased) and subscription are required. For more information, visits www.siriusxm.com.

Activating subscription

1 Check your Radio ID.

Radio ID is labeled on the casing of the SiriusXM Connect Vehicle Tuner or the bottom of the SiriusXM Connect Vehicle Tuner unit.

- You can also display the Radio ID on the screen by tuning in to Channel 0.

2 To listen to SiriusXM Satellite Radio, a subscription is required. Activate the SiriusXM Connect Vehicle Tuner using one of the two methods below:

- Online: Go to www.siriusxm.com/activatenow
- Phone: Call 1-866-635-2349

3 Select “Satellite” as the source. (☞ page 12)

SiriusXM Connect Vehicle Tuner starts updating all the SiriusXM channels.

Tuning in to a channel

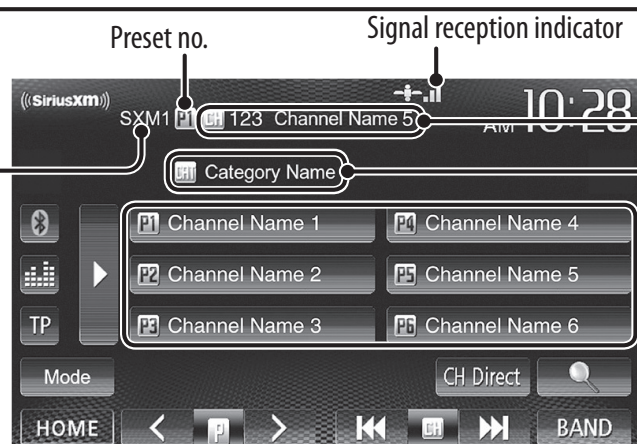

The screenshot shows the radio's display with various controls and information. Labels point to: Preset no. (P1-P6), Signal reception indicator, Channel no./Channel name (123 Channel Name 5), Category name (Category Name), Band (SXM1), and a Preset list (Channel Name 1-6). The bottom of the screen shows navigation buttons: HOME, left arrow, P, right arrow, CH Direct, and BAND.

[P1] – [P6]	<ul style="list-style-type: none"> Selects a stored channel. (Press) Stores the current channel. (Hold) 	[BAND]	<p>Selects the band.</p> <p>→ SXM1 → SXM2 → SXM3 → SXM4 →</p>
[▶]	Displays/hides the information on the current channel. (☞ page 36)	[◀◀] [▶▶]	<ul style="list-style-type: none"> Selects a channel. (Press) Changes the channel rapidly. (Hold) <ul style="list-style-type: none"> While searching, invalid, skipped and unsubscribed channels are skipped.
[🔍]	Displays the Category/Channel List. (☞ page 36)	[<] [>]	Selects a stored channel.
[CH Direct]	Displays the <Direct Channel Number> screen. (☞ page 36)	[Mode]	Changes the settings for restrictions. (☞ page 37)
		[HOME]	Displays the <HOME> screen.

■ Displaying the information on the current channel



Hides the text information

Text information

Scrolls the text information

■ Storing channels in memory

You can preset six channels for each band.

- 1 Tune in to a channel you want to preset.
(☞ page 35)
- 2 Select a preset number.



The channel selected in step 1 is stored.

■ Selecting a preset channel



Also changes preset channels

■ Selecting a channel on the list

- 1
- 2 Select a category (①), and then select a channel (②).

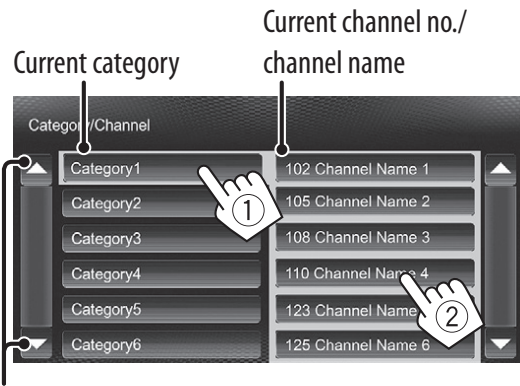

Changes the page

■ Selecting a channel directly

- 1
- 2 Enter a channel no. (①), and then confirm (②).

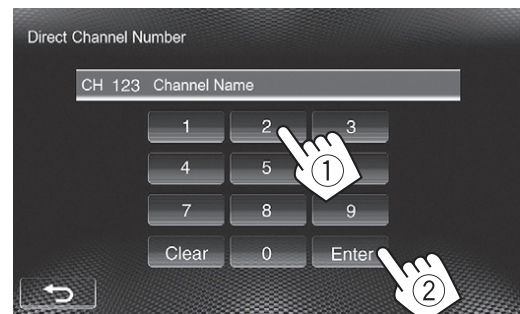

• To clear the entry, press [Clear].

Setting the reception restrictions

Setting the parental lock

You can set the parental lock in order to, for example, restrict children from receiving adult channels.

Setting the parental code

- The initial setting is "0000."
- Changing the code does not change the <P.Lock Channel Select> and <Skip Channel Select> settings.

1 Display the <Parental Code> screen.

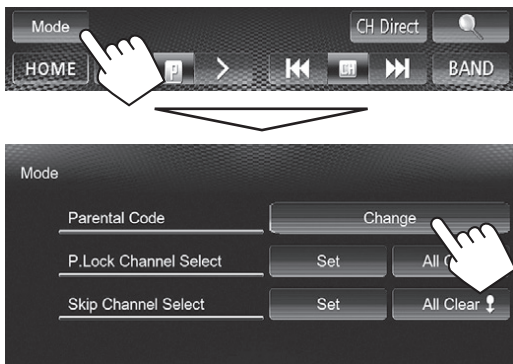

2 Enter the current code in <Current Code>, a new code in <New Code>, and then the new code again for confirmation the entry in <Confirm Code>.

- ① Enter a code.
- ② Confirm the entry.

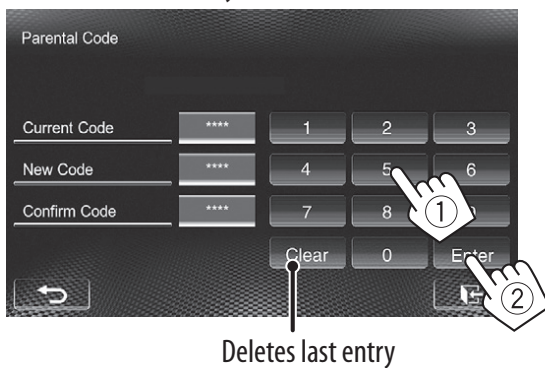

- To change the parental code, press [Change] on step 1, enter current code, then new code on step 2 above.

Activating the parental lock

1 On <Mode> screen:

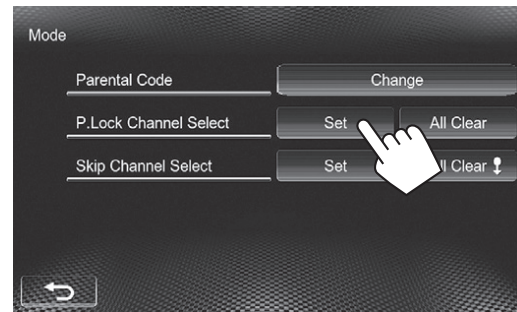

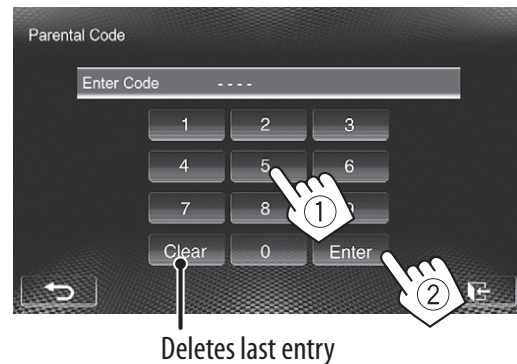

2 Enter your parental code number (①), then confirm the entry (②).

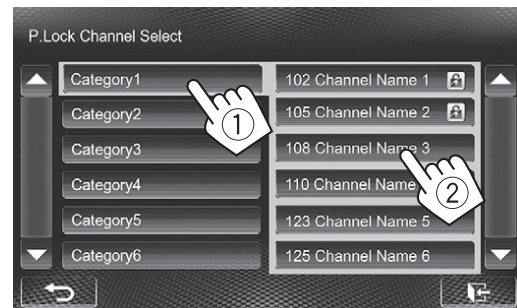

3 Select a category (①), and then a channel you want to activate the parental lock for (②).



The  icon appears beside the channel with the parental lock activated.

- **To cancel the selection**, select the locked channel again in Step 3. The  icon disappears and the selection is canceled.
- When you try to receive a channel with the parental lock activated, the parental code input screen appears and you cannot receive the channel until you enter the correct code.

Clearing the parental lock for all locked channel

1 On <Mode> screen:

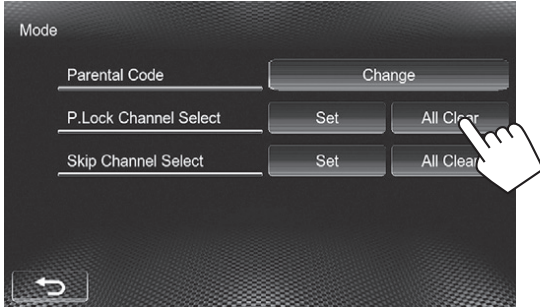

2 Enter your parental code number (1), and then confirm the entry (2).

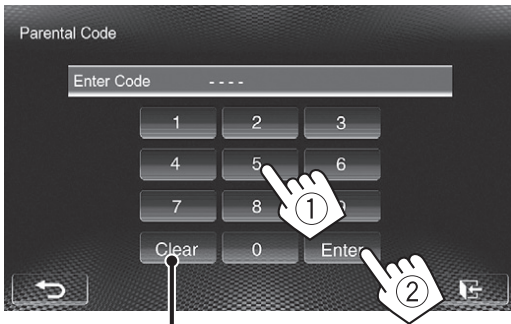

Deletes last entry

Skipping unwanted channels

If you do not want to receive some channels, you can skip them.

Setting the channel skipping

1 **Activate the channel skip.**

On <Mode> screen:

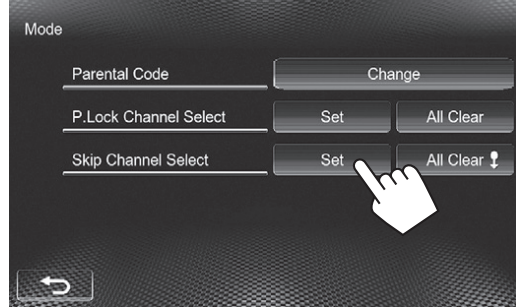

2 **Select a category (1), and then select a channel you want to skip (2)**

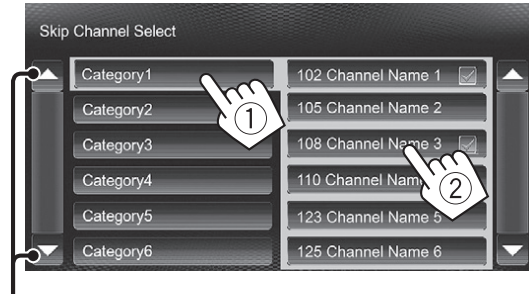

Changes the page

The icon appears beside the selected channels.

- Repeat this step if you want to skip more channels.

Clearing the channel skipping for all skipped channels

On <Mode> screen:

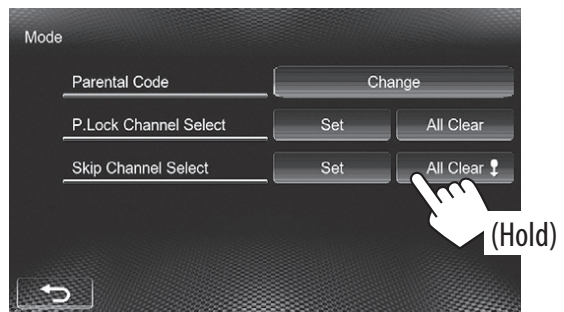

Sound adjustment

Using the sound equalization

- The adjustment is memorized for each source until you adjust the sound again. If the source is a disc, the adjustment is stored for each of the following categories.
 - DVD/DVD-VR/VCD
 - CD
 - DivX/MPEG1/MPEG2/MP3/WMA/WAV
- You cannot adjust the sound when the AV source is turned off.

Selecting a preset sound mode

1 On <HOME> screen:

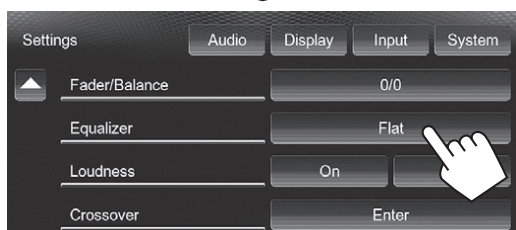

OR

On the source control screen:

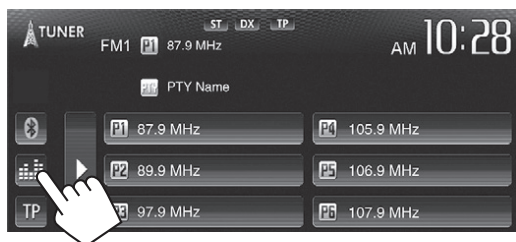

2 Select a sound mode.

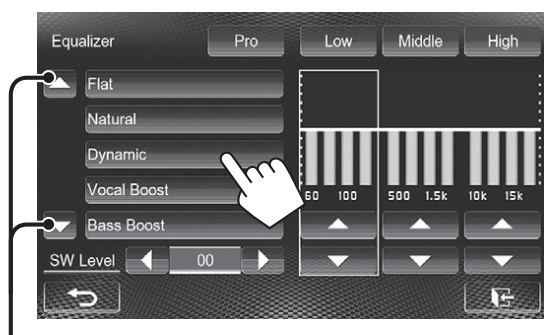

Changes the page

Storing your own adjustment

Customizing preset sound mode

- 1 Select a sound mode. (☞ “Selecting a preset sound mode”)
- 2 Adjust the level of each band (①), then select the subwoofer level (②).

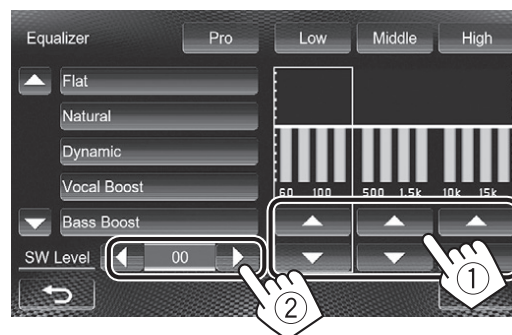

The adjustments are stored and <User> is activated.

- To finish the procedure, press [↩].
- To make precise adjustments, ☞ page 40.

Adjusting the sound precisely

- 1 Perform steps 1 and 2 of "Selecting a preset sound mode," then...

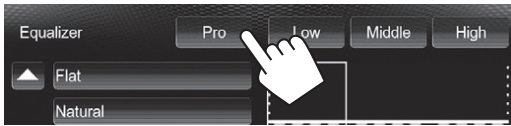

- 2 Select a band.



- 3 Adjust the sound.

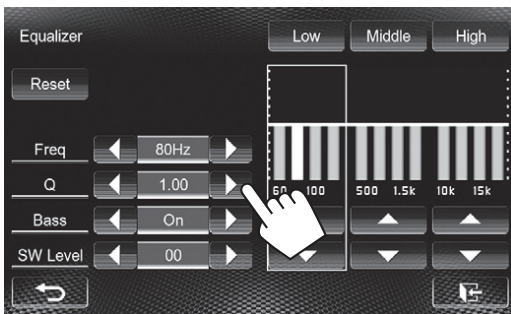

Reset	Changes level of Low/Mid/High to 0.
Freq	Selects frequency.
Q	Adjusts the width of the frequency.*1
Bass	Activates/deactivates bass.*2
SW Level	Adjusts subwoofer level.

The adjustments are overwritten if the <User> setting has been made (☞ page 39), and <User> is activated.

- The adjustments are memorized until you adjust sound again.
- To make adjustment for other bands, repeat steps 2 and 3.

*1 Fixed for "High" band.

*2 Only for "Low" band.

Adjusting the crossover frequency

- 1 On <HOME> screen:



- 2



- 3 Select the item to adjust, then make adjustments.

Adjusts the crossover for front or rear speakers (high pass filter).

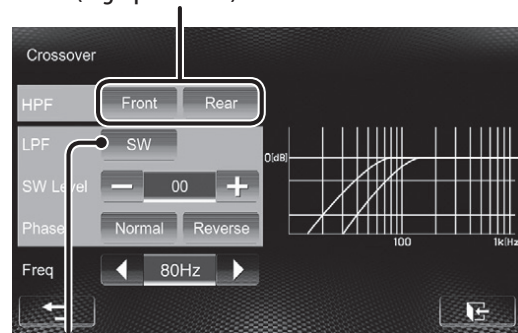

Adjusts the crossover for subwoofer (low pass filter).

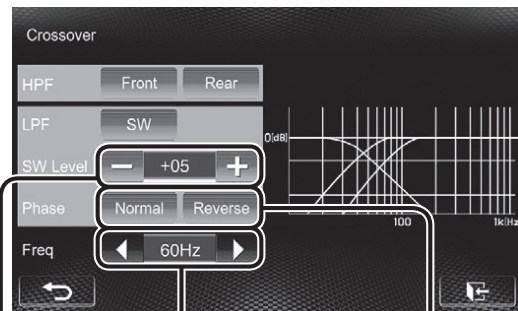

Adjusts the crossover frequency.

Selects the phase for the subwoofer.*

Adjusts the subwoofer level.

* Not selectable when <Freq> is set to <Through>.

Changing display design

You can change the background, the color of text, touch panel buttons, and monitor panel buttons.

1 On <HOME> screen:



2

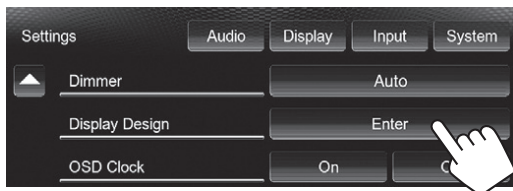

3 Select an item ([Backgrnd], [Text] or [Buttons]), then change the setting.

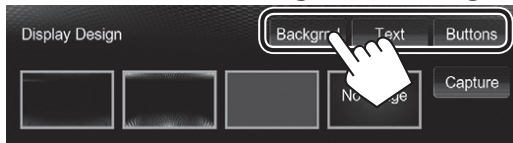

Background

① Select a background

Basic image (default)



You can select a color on the color palette or adjust the color on the user color adjuster. (☞ the right column)

For setting your favorite scene as the background, ☞ page 42

② Select/adjust the color



Color palette

Dimmer setting: You can make selections for each dimmer setting—[☾] (Dimmer On) or [☀] (Dimmer Off).

User color adjuster: You can make your own color adjustment and store it to <User>.

Text/Buttons

Select/adjust the color. (For details, ☞ above.)

Variable color illumination*

- Illumination color changes gradually.

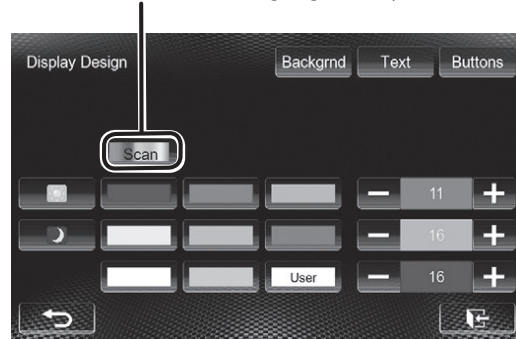

* Appears only for button color selecting screen. When variable color illumination is selected, you cannot adjust the color.

Using your favorite scene as the background

While playing a video or JPEG, you can capture an image and use the captured image as a background.

- You cannot capture copyrighted content and image from iPod/iPhone.
- When using a JPEG file as the background, make sure that the resolution is 800 x 600 pixels.
- The color of the captured image may look different from that of the actual scene.

- 1 Play a video or JPEG.
- 2 Display the <Display Design> screen.
(☞ page 41)

3

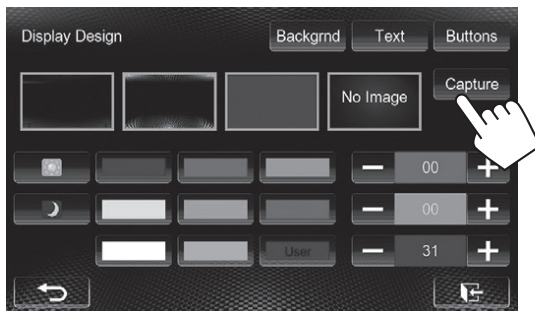

- 4 Adjust the image.



- [▶/⏸]*¹ Starts/pauses playback.
- [⏮▶]*¹ Advances scenes frame-by-frame.
- [▶] Magnifies the scene. (<Full>, <Zoom1> – <Zoom3>)
- [▲] [▼] Moves the zooming frame.
- [◀] [▶]*²
- To cancel the capture, press [↶].

*¹ Not displayed when playing an external component connected to LINE IN/VIDEO IN jacks.

*² Not displayed when <Full> is selected.

- 5 Capture the image displayed on the screen.



A confirmation message appears. Press [Yes] to store the newly captured image. (The existing image is replaced with the new one.)

- Press [No] to return to the previous screen.

Setting for video playback

You can change the setting for video playback.

Adjusting the picture

You can adjust the picture quality.

1 Display the adjustment menu.

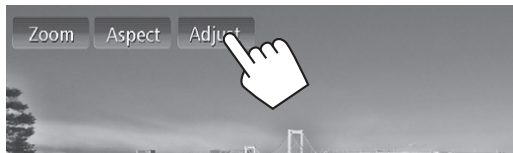
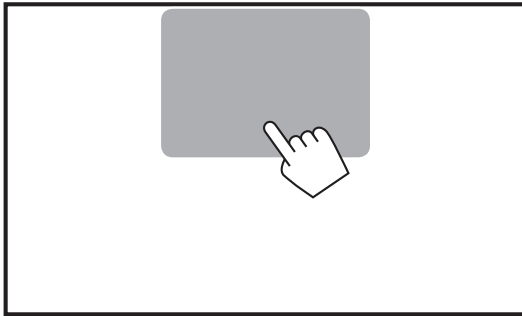

2 Select [☾] (dimmer on) or [☀] (dimmer off).

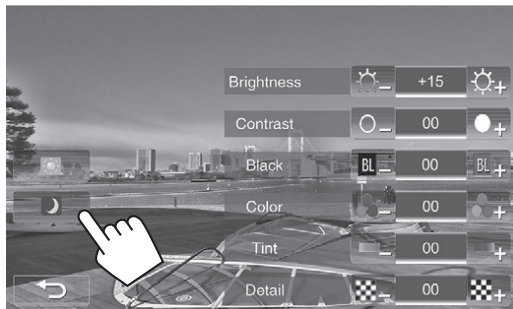

3 Adjust the picture (-15 to +15).

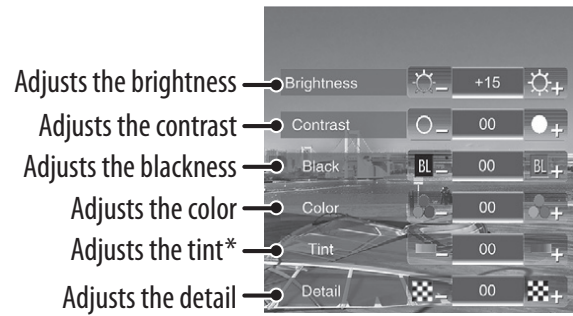

* Adjustable only when the incoming signal is NTSC.

Changing the aspect ratio

You can change the aspect ratio for video playback.

1

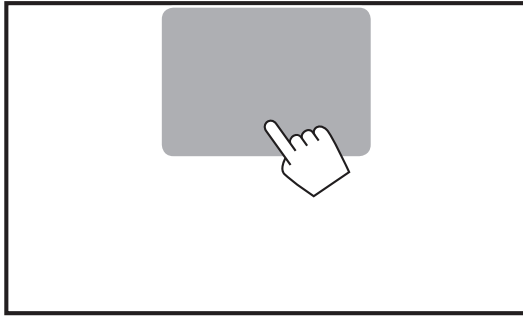

2



	4:3 signal	16:9 signal
Full*: For 16:9 original pictures		
Panorama: For viewing 4:3 pictures naturally on the wide screen		
Regular*: For 4:3 original pictures		
Auto:	<ul style="list-style-type: none"> For "DISC"/"USB" only: The aspect ratio is automatically selected to match the incoming signals. 	

* While DivX is played back with <Monitor Type> set to [16:9] (see page 23), the aspect ratio is not set correctly.

Zooming the picture

You can zoom the picture (<Full>, <Zoom1> to <Zoom3>).

- When <Aspect> is set to <Panorama> or <Auto> (see the left column), the picture is zoomed with the aspect ratio of the <Full> setting.

1

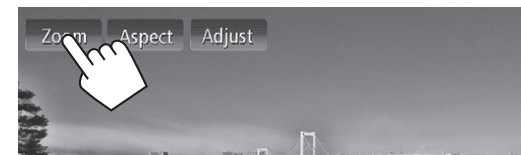
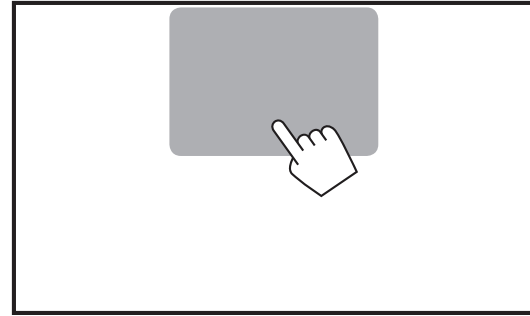

2



[▲] [▼] [◀] [▶]*: Moves the zooming frame.

* Not displayed when <Full> is selected.

- The zoom function cannot be used for some video sources.

Using a rear view camera

- To use a rear view camera, the REVERSE GEAR SIGNAL lead connection is required. For connecting a rear view camera, see Installation/Connection Manual.

Activating the rear view camera

1 On <HOME> screen:

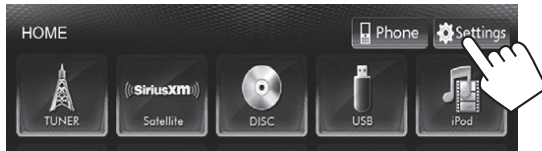

2

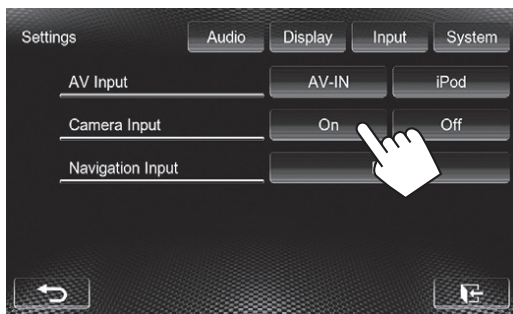

To deactivate, select [Off].

Displaying the picture from the rear view camera

The rear view screen is displayed when you shift the gear to the reverse (R) position.

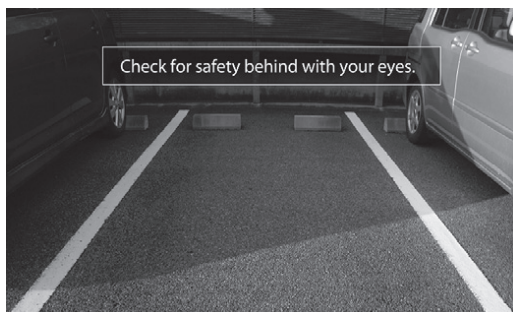

- For KW-ADV65BT/KW-AV61BT Region 1/KW-AV61 Region 1: To erase the caution message, touch the screen.

To display the picture from the rear view camera manually

On <HOME> screen:



When displaying the picture from the rear view camera manually, you can change the setting of the picture. (see pages 43 and 44)

To erase the rear view screen



Setting menu items



- When changing settings for **<Amplifier Gain>**, **<AV Input>**, and **<Input>** in **<Navigation Input>**, turn off the AV source. Other settings can be changed when the AV source is turned on.

Menu item	Selectable setting/item	Initial: <u>Underlined</u>
Audio	Fader/Balance	<p>Fader : Adjust the front and rear speaker output balance. ◆ F6 to R6; Initial <u>0</u></p> <ul style="list-style-type: none"> • When using a two-speaker system, set the fader to the center (<u>0</u>). <p>Balance : Adjust the left and right speaker output balance. ◆ L6 to R6; Initial <u>0</u></p> <p>Press [▲/▼/◀/▶] or drag [+] to adjust.</p> <ul style="list-style-type: none"> • To clear the adjustment, press [Center].
	Equalizer	<p>Change the sound mode or adjust and store the equalization for each source. (🔊 page 39)</p> <p>◆ Flat/Natural/Dynamic/Vocal Boost/Bass Boost/Vibrant/User</p>
	Loudness	<p>You can activate/deactivate loudness.</p> <p>◆ On : Boost low and high frequencies to produce a well-balanced sound at a low volume level.</p> <p>◆ Off : Cancels.</p>
	Crossover	<p>Adjust the crossover frequency. (🔊 page 40)</p>
	Volume Adjust	<p>Adjust and store the auto-adjustment volume level for each source. (For discs, the adjustment is stored for each of the following categories: DVD/DVD-VR/VCD, CD, and DivX/MPEG1/MPEG2/MP3/WMA/WAV.) The volume level will automatically increase or decrease when you change the source.</p> <p>◆ -15 to +6; Initial <u>0</u></p>
	Amplifier Gain*	<p>◆ On : Activates the built-in amplifier.</p> <p>◆ Off : Deactivates the built-in amplifier.</p>
	Speaker Select	<p>Select the size of the connected speaker.</p> <p>◆ Standard/Narrow/Middle/Wide</p>

* To change the setting, turn off the AV source by pressing [**AV Off**] on the **<HOME>** screen beforehand.

Menu item	Selectable setting/item	Initial: <u>Underlined</u>
Display	Dimmer	<ul style="list-style-type: none"> ◆ Auto : Dims the screen and button illumination when you turn on the headlights. <ul style="list-style-type: none"> • The ILLUMI lead connection is required. (☞ Installation/Connection Manual) ◆ On : Activates dimmer. ◆ Off : Cancels. ◆ Dimmer Time Set : Sets the Dimmer On (☾)/Off (☼) times. <ul style="list-style-type: none"> • Press [▲] or [▼] to set the time.
	Display Design	Change the display design (background, the color of text, touch panel buttons, and monitor panel buttons). (☞ page 41)
	OSD Clock	<ul style="list-style-type: none"> ◆ On : Displays the clock while a video source is played back. ◆ Off : Cancels.
	Demonstration	<ul style="list-style-type: none"> ◆ On : Activates the demonstration on the screen. ◆ Off : Cancels.
	Scroll	<ul style="list-style-type: none"> ◆ Auto : Repeats scrolling. ◆ Once : Scrolls the displayed information once. ◆ Off : Cancels. • Touching the information bar scrolls the text regardless of this setting.
	GUI Adjust	<p>Adjust the brightness and blackness of the screen. Press [Enter] to display the setting screen, select [☾] (dimmer on)/[☼] (dimmer off), then change the following settings:</p> <ul style="list-style-type: none"> ◆ Brightness : Adjusts brightness (-15 to +15; Initial <u>00</u> for Dimmer On/+15 for Dimmer Off). ◆ Black : Adjusts blackness (-15 to +15; Initial <u>00</u>).
	NTSC/PAL *1	Select the color system of the external monitor. ◆ NTSC, PAL
Input	AV Input *2*3	<p>You can determine the use of LINE IN/VIDEO IN jacks.</p> <ul style="list-style-type: none"> ◆ AV-IN*4 : Select to use the external component connected to LINE IN/VIDEO IN jacks or the iPod/iPhone connected by using USB 2.0 cable. (☞ pages 26 and 34) ◆ iPod : Select to use the iPod/iPhone connected by using JVC KS-U30. (☞ page 26) ◆ BT*4*5 : Select when playing back the Bluetooth audio player using the Bluetooth adapter (KS-BTA100). (☞ page 61)

*1 "Please Power Off" appears when the setting is changed. Turn off the power, then turn on to enable the change.

*2 To change the setting, turn off the AV source by pressing [**AV Off**] on the <HOME> screen beforehand. <AV Input> can be changed only when <Input> in <Navigation Input> is set to [**Off**].

*3 The initial setting is [**iPod**] for KW-ADV65BT/KW-AV61BT Region 1/KW-AV61 Region 1, and [**AV-IN**] for KW-AV61BT Region 4/KW-AV61 Region 4.

*4 When <AV Input> is set to [**AV-IN**] or [**BT**], the video from iPod/iPhone is not displayed on the screen.

*5 Only for KW-AV61.

Menu item	Selectable setting/item	Initial: <u>Underlined</u>
Input	Camera Input	<ul style="list-style-type: none"> ◆ <u>On</u> : Displays the picture from the rear view camera when you shift the gear to the reverse (R) position. ◆ <u>Off</u> : Select this when no camera is connected.
	Navigation Input	<p>Change the settings for displaying the screen of App from the connected iPod touch/iPhone. (☞ page 30)</p> <ul style="list-style-type: none"> • <Navigation Mute> is not used for this unit.
System	Language	<p>Select the text language used for on-screen information.</p> <ul style="list-style-type: none"> ◆ <u>English/Español/Français/Deutsch/Italiano/Nederlands/Svenska/Dansk/Русский/Português</u> • “Please Power Off” appears when the setting is changed. Turn off the power, then turn on to enable the change. ◆ GUI Language : Select a language (<<u>English</u>> or <Local>: the language selected above) used for displaying operation buttons and menu items.
	Time Set	Adjust the clock time. (☞ page 8)
	Beep	<ul style="list-style-type: none"> ◆ <u>On</u> : Activates the key-touch tone. ◆ <u>Off</u> : Cancels.
	User Profile	You can memorize, recall, or clear the settings you have made. (☞ page 49)
	Touch Panel Adjust	Adjust the touch position of the buttons on the screen. (☞ page 50)
	Initialize	<p>Initialize all settings you have made. Hold [Enter] to initialize the settings.</p> <ul style="list-style-type: none"> • After initializing the settings, adjust the settings on the <Initial Settings> screen. (☞ page 7)
	Bluetooth Setup *1	Configure settings for using a Bluetooth device, such as connection and other general operations. (☞ page 54)
	DivX® VOD *2	<p>This unit has its own Registration Code. Once you have played back a file with the Registration Code recorded, this unit’s Registration Code is overwritten for copyright protection.</p> <ul style="list-style-type: none"> • Press [Enter] to display the information. • To return to the previous screen, press [OK].
	System Information	Displays the version information on the software. You can update the software. (☞ page 50)

*1 Only for KW-ADV65BT/KW-AV61BT.

*2 Only for KW-ADV65BT/KW-AV61BT Region 1/KW-AV61 Region 1.

Memorizing/recalling the settings

You can memorize the following settings:

- Settings on the <Settings> screen: **Fader/Balance, Equalizer, Loudness, Crossover** (HPF/LPF/SW Level settings), **Volume Adjust, Speaker Select, Dimmer, Display Design, AV Input, Camera Input**
- Settings for "AV-IN": **AV-IN Name**

Memorizing your settings

1 On <Settings> screen:

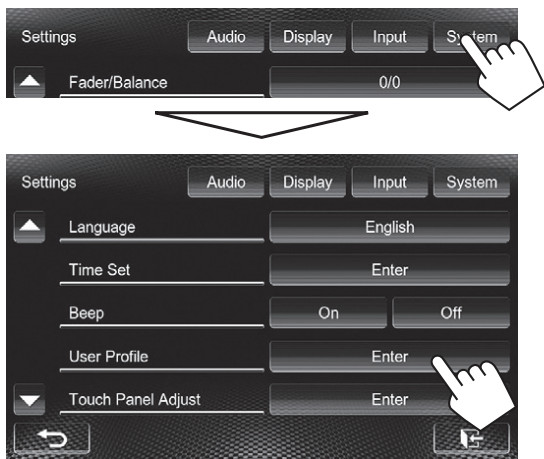

2

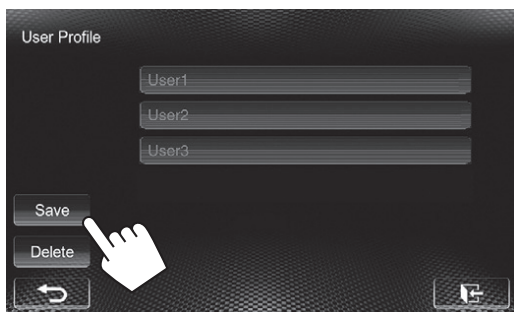

3 Select an item ([User1], [User2] or [User3]) to memorize the settings.



A confirmation message appears. Press [Yes].

4 Finish the procedure.



Recalling your settings

- Turn off the AV source by pressing [AV Off] on the <HOME> screen beforehand.

1 On <User Profile> screen (step 2 on the left column):



A confirmation message appears. Press [Yes].

2 Finish the procedure.



Clearing your settings

1 On <User Profile> screen (step 2 on the left column):



2

Clears all settings memorized in [User1], [User2] and [User3]

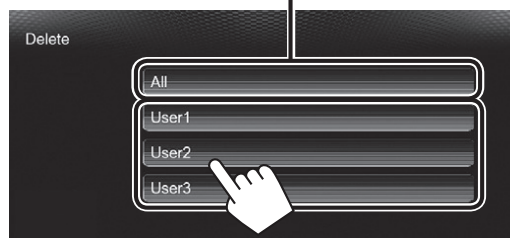

A confirmation message appears. Press [Yes].

3 Finish the procedure.



Updating the system

You can update the system by connecting a USB device containing an update file.

1 Create an update file, copy it to a USB device, and connect it to the unit.

- To connect a USB device,  page 24.

2 On <Settings> screen:

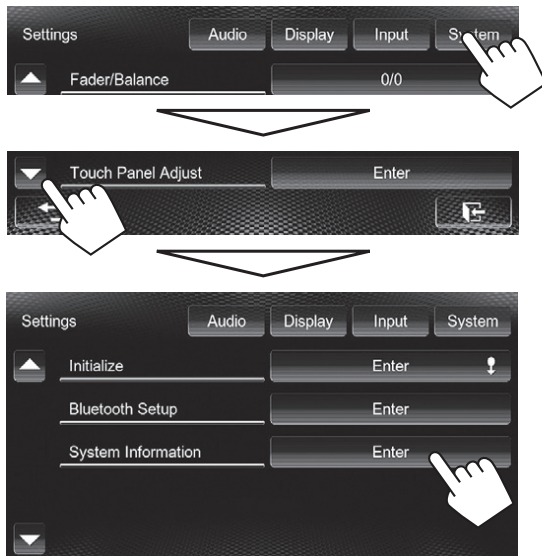

3

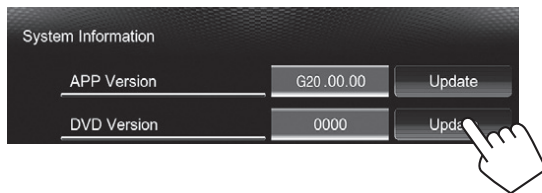

APP Version	Updates the system application.
DVD Version	Updates the DVD system application.

It may take a while.

If the update has been completed successfully, "Update Completed" appears. Reset the unit.

- If the update has failed, turn the power off and then on, and retry the update.
- Even if you have turned off the power during the update, you can restart the update after the power is turned on. The update will be performed from the beginning.

Adjusting the touch position

You can adjust the touch position on the touch panel if the position touched and the operation performed do not match.

1 On <Settings> screen:

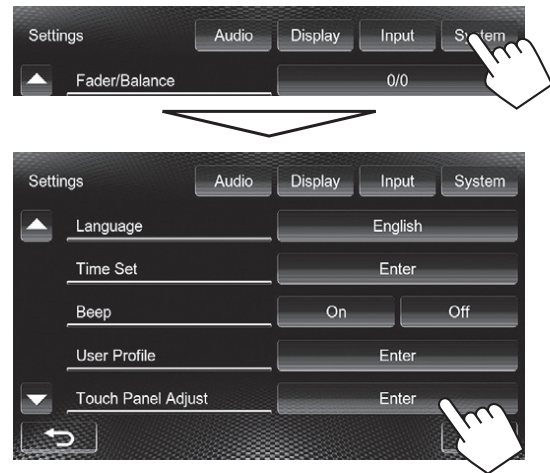

2 Touch the center of the marks at the lower left and at the upper right as instructed.

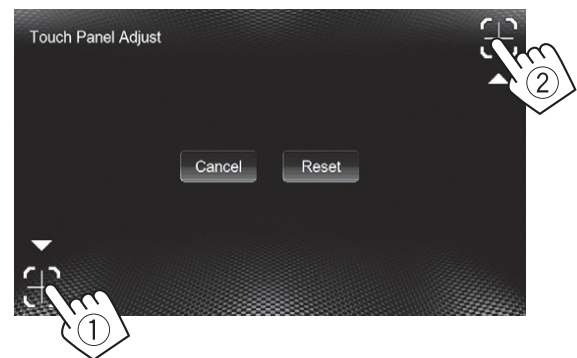

- To reset the touch position, press [**Reset**].
- To cancel the current operation, press [**Cancel**].

BLUETOOTH OPERATIONS

Information for using Bluetooth® devices

- Some Bluetooth devices may not be connected to this unit depending on the Bluetooth version of the device.
- This unit may not work for some Bluetooth devices.
- Connecting condition may vary depending on circumstances around you.
- For some Bluetooth devices, the device is disconnected when the unit is turned off.

Bluetooth Information: If you wish to receive more information about Bluetooth, visit the following JVC web site: <<http://www3.jvckenwood.com/english/car/>> (English website only)

ENGLISH

Bluetooth operations for KW-ADV65BT/KW-AV61BT

Bluetooth®

Bluetooth is a short-range wireless radio communication technology for the mobile device such as mobile phones, portable PCs, and other devices. The Bluetooth devices can be connected without cables and communicate with each other.





- Refer to pages i and ii at the end of manual to check the countries where you may use the Bluetooth® function.

Bluetooth profile

This unit supports the following Bluetooth profiles;

- HFP (Hands-Free Profile) 1.5
- OPP (Object Push Profile) 1.1
- A2DP (Advanced Audio Distribution Profile) 1.2
- AVRCP (Audio/Video Remote Control Profile) 1.3
- PBAP (Phone Book Access Profile) 1.0
- SPP (Serial Port Profile)

Icons for Bluetooth button

-  : No device is connected.
-  : A Bluetooth audio player is connected.
-  : A Bluetooth mobile phone is connected.
-  : Both a Bluetooth mobile phone and audio player are connected.

When shipped from the factory, the Bluetooth adapter (KS-UBT1) is attached.

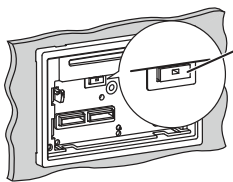

Bluetooth adapter (KS-UBT1)

- Keep the Bluetooth adapter attached when using the Bluetooth function.
- This port is designed for the use with KS-UBT1 only. Other Bluetooth adapters or USB devices cannot be used.

Connecting Bluetooth devices

■ Registering a new Bluetooth device

When you connect a Bluetooth device to the unit for the first time, make pairing between the unit and the device. Pairing allows Bluetooth devices to communicate each other.

- The pairing method differs depending on the Bluetooth version of the device.
 - For the device with Bluetooth 2.1: You can pair the device and the unit using SSP (Secure Simple Pairing) which only requires confirmation.
 - For the device with Bluetooth 2.0: You need to enter a PIN code both on the device and unit for pairing.
- Once the connection is established, it is registered in the unit even if you reset the unit. Up to 5 devices can be registered in total.
- Only one device for Bluetooth phone and one for Bluetooth audio can be connected at a time.
- To use the Bluetooth function, you need to turn on Bluetooth function of the device.
- To use the registered device, you need to connect the device to the unit. (☞ page 53)

Pairing a Bluetooth device using SSP (for Bluetooth 2.1)

When the Bluetooth device is compatible with Bluetooth 2.1, pairing request is sent from an available device. Confirm the request both on the device and the unit.

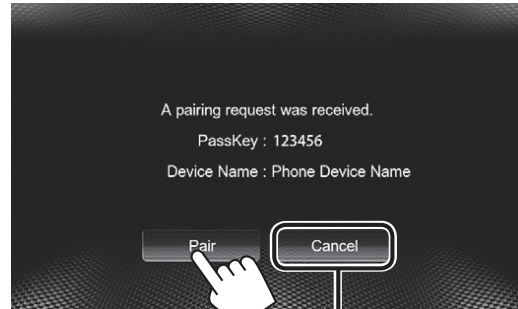

Rejects the request

Pairing a Bluetooth device using a PIN code (for Bluetooth 2.0)

- 1 On <Settings> screen:

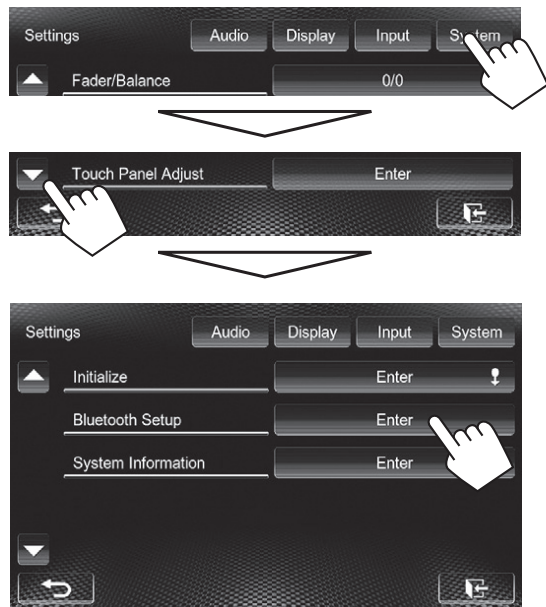

The <Bluetooth Setup> screen is displayed.

2 Change the PIN code.

- You can skip changing the PIN code.
- The maximum digit of the PIN code that can be set is 16.

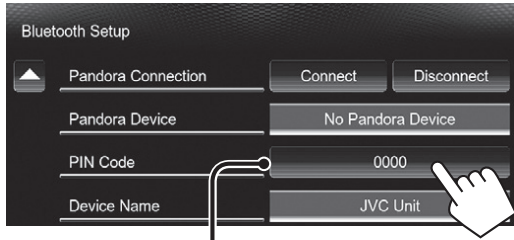

PIN code (initial: 0000)

Deletes last entry

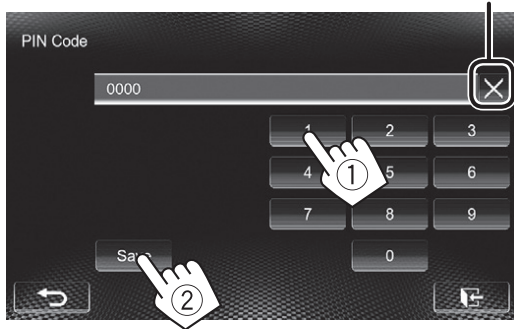

- The Bluetooth connection by **<Audio Connection>** is only available when **"Pandora"*** or **"BT Audio"** is selected as the source.
- The Bluetooth connection by **<Pandora Connection>** is only available when **"Pandora"** is selected as the source.*

3 Operate the Bluetooth device to complete pairing.

When pairing is complete, the device is listed on **<Connect Device>**. To use the paired device, connect the device on **<Connect Device>** (the right column).

* Only for KW-ADV65BT/KW-AV61BT Region 1/KW-AV61 Region 1.

Connecting/disconnecting a registered Bluetooth device

1 Display the <Bluetooth Setup> screen. (page 52)

2 To connect

Select **[Connect]** for the target device, and then select the device you want to connect.

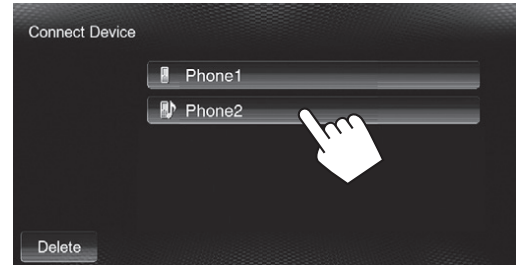

"Connected" appears. Press **[OK]** to confirm the operation.

- All registered devices (mobile phone and audio player) are listed on **<Connect Device>**.
 - Selectable items depend on the device you are operating.

To disconnect

Select **[Disconnect]** for the target device. A confirmation message appears. Press **[Yes]**.

Deleting a registered Bluetooth device

1 On **<Connect Device>** screen (Step 2 above)



2 Select a device to delete.

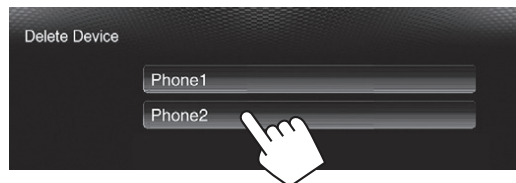

A confirmation message appears. Press **[Yes]**.

To detach the Bluetooth adapter

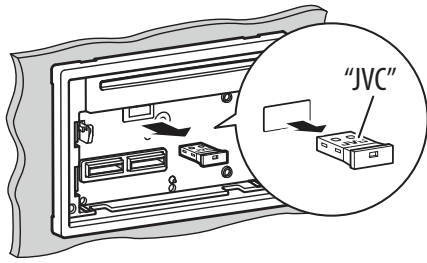

- Store the Bluetooth adapter in the supplied bag.
- When inserting the Bluetooth adapter again, attach it firmly with the JVC logo facing up.

Setting up Bluetooth

To display the <Bluetooth Setup> screen, page 52.

Menu items	Selectable setting/item	Initial: <u>Underlined</u>
Phone Connection	<ul style="list-style-type: none"> ◆ Connect : page 53 ◆ Disconnect : page 53 	
Phone Device	Shows the phone device name.	
Audio Connection	<ul style="list-style-type: none"> ◆ Connect : page 53 ◆ Disconnect : page 53 	
Audio Device	Shows the audio device name.	
Pandora Connection*	<ul style="list-style-type: none"> ◆ Connect : page 53 ◆ Disconnect : page 53 	
Pandora Device*	Shows the Pandora device name.	
PIN Code	Changes the PIN code of the unit. (page 52) <ul style="list-style-type: none"> • Touch the current PIN code, enter a new PIN code, then press [Save]. 	
Device Name	Shows the device name to be shown on the Bluetooth device—JVC Unit.	
Device Address	Shows the MAC address of the unit.	
Auto Connect	<ul style="list-style-type: none"> ◆ On : The connection is automatically established with the last connected Bluetooth device when the unit is turned on. ◆ Off : Cancels. 	
HF/Audio Output	Select the speakers used for Bluetooth (both phone and audio player). <ul style="list-style-type: none"> ◆ Front : From front speakers only. ◆ All : From all speakers. 	
Initialize	Hold [Enter] to clear the registration of Bluetooth devices and memory of the preset list and call lists.	

* Only for KW-ADV65BT/KW-AV61BT Region 1/KW-AV61 Region 1.

Using the Bluetooth mobile phone

Receiving a call

When a call comes in...

Status of the device/Battery reminder (only when the information comes from the device) Call information (if acquired)

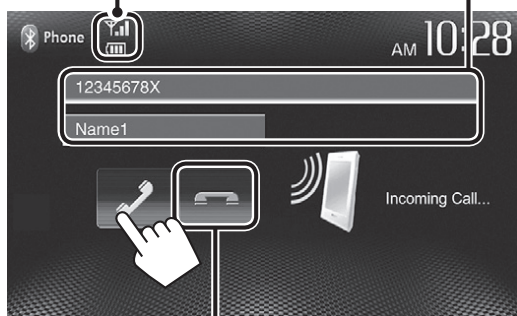

Rejects the call

- Phone operation is not available while the picture from the rear view camera is displayed. (👉 page 45)

When <Auto Answer> is set to [On]

The unit answers the incoming call automatically.

(👉 page 59)

Ending a call

While talking...

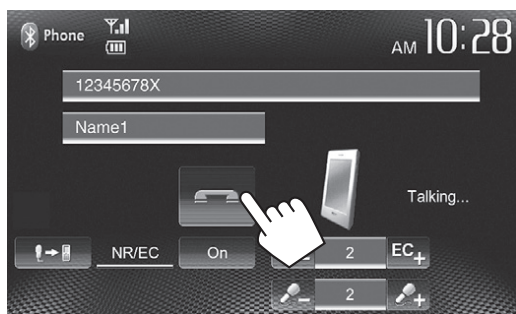

Adjusting the volume of microphone

While talking...

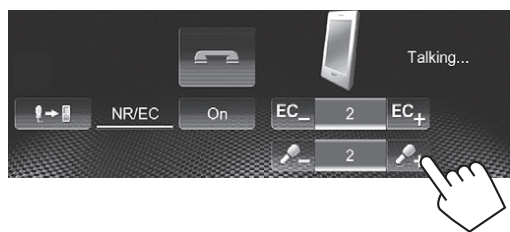

- This adjustment does not affect the volume level of the other sources.
- To adjust the volume of calls/earpiece, turn the volume adjustment knob.

Switching between handsfree mode and phone mode

While talking...

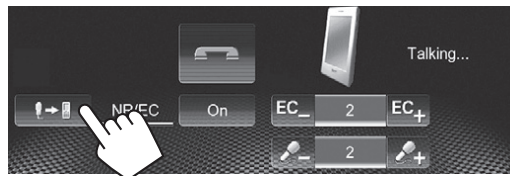

Each time you press the button, the talking method is switched (📞👉 : handsfree mode / 📞👈 : phone mode).

Notifying SMS reception

If the mobile phone is compatible with SMS (Short Message Service), the unit tells you a message has been received. (👉 page 59)

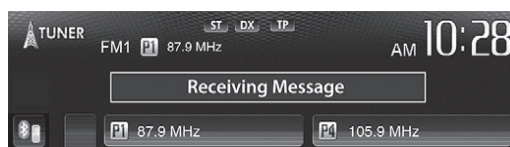

To read a received message, operate the mobile phone after stopping the car in a safe place.

- You cannot read, edit, or send a message through the unit.

- For some mobile phones, the notification message may not be shown even if the SMS function is supported.

Making a call

1 On the source control screen:



- You can also display the phone control screen by pressing [Phone] on the <HOME> screen.



2 Select a method to make a call.

Direct number entry
(the right column)

Preset list/phone book/call lists
(page 57)

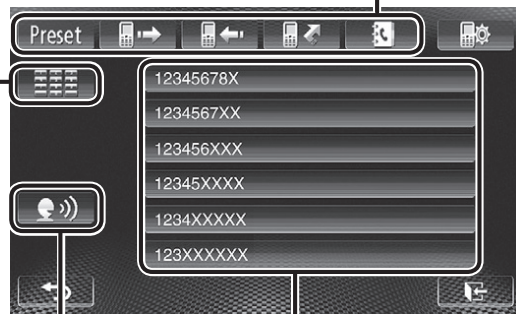

Preset list (For presetting, page 58)

Voice dialing (the right column)

Direct number entry

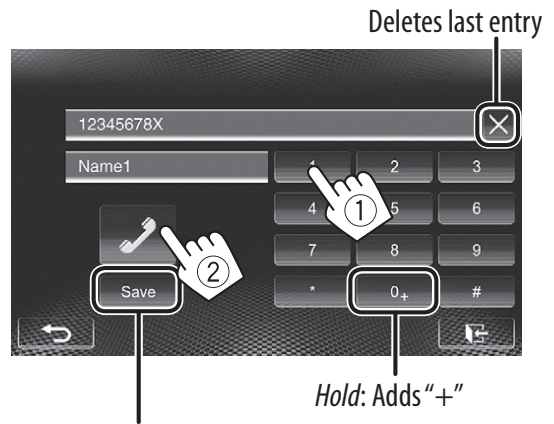

Presets the entered phone number on the preset list (page 58)

- You can enter up to 32 numbers.

Voice dialing

- Available only when the connected mobile phone has the voice recognition system.

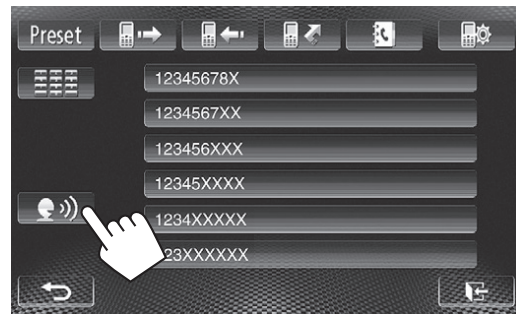

Speak the name you want to call.

To cancel, press [Cancel].

To reduce echo/noise while talking

Make sure that the NR/EC (Noise reduction/Echo cancel) function is activated on the screen while talking.

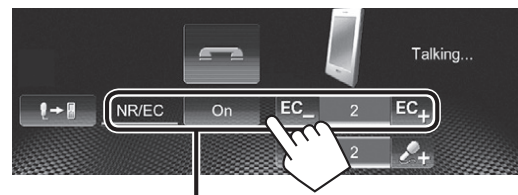

Select [On] to reduce the noise and cancel the echo while talking. To adjust the echo volume, press [EC -]/[EC +].

Using the preset list/phone book/call lists

1



Preset	From preset list
	From dialled call list.
	From received call list.
	From missed call list.
	From phone book. • For copying the phone book, see page 58.

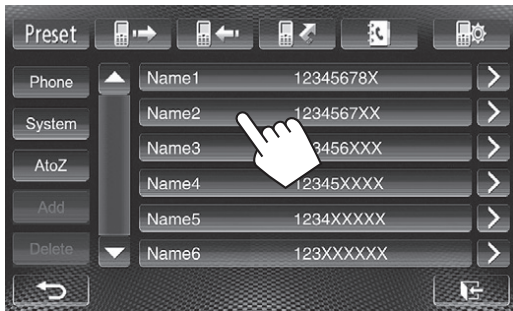

2



To use the A to Z search on phone book

When phone book list screen is displayed, you can search by initial.

1

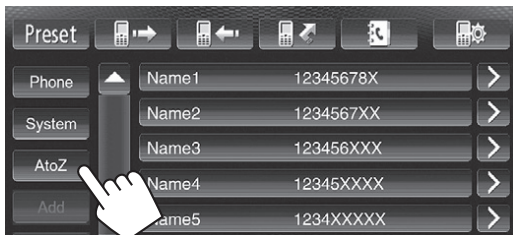

2 Select the initial.



Displays the other letters

3 Select a phone number from the list.

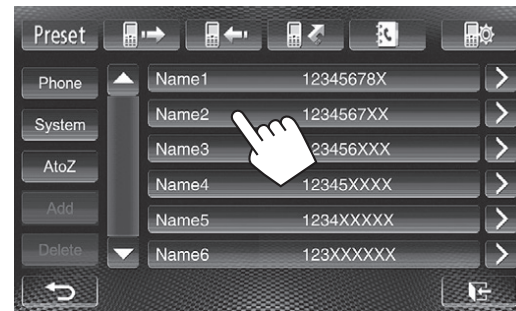

To display the details of an entry

When phone book list screen is displayed, you can display the details of an entry and select a phone number if several phone numbers are registered.

1 Display the details of the desired entry.



2 Select a phone number to call.

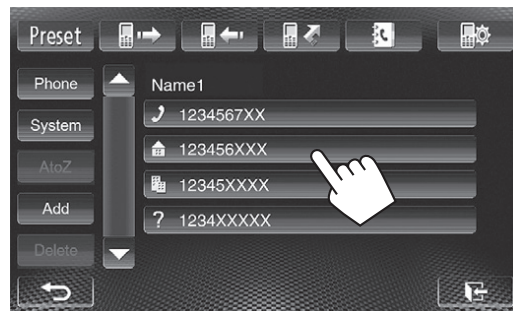

■ Presetting the phone numbers

You can preset up to 6 phone numbers.

1 On the source control screen:



2 Select an item from phone book/call lists.

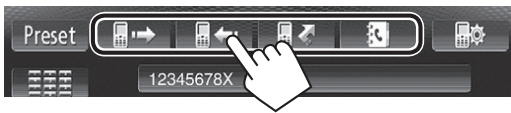

3 Select a phone number.



4 Select a preset number to store into.



- You can also preset a phone number entered on the direct number entry screen by pressing [Save]. (→ page 56)

■ Copying the phone book

You can copy the phone book memory of a mobile phone into the unit (up to 400 entries).

1 On the source control screen:



2



PIN code (initial: 0000)

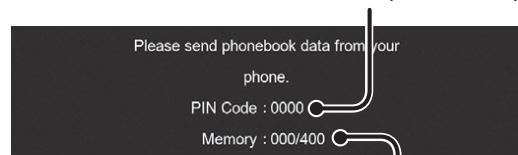

Numbers of the phone book entries copied

3 Operate the target mobile phone.

- Refer to the instruction manual supplied with your mobile phone.
- To cancel the transfer, press [Finish].

4 Finish the procedure.



The phone book memory is copied from the mobile phone.

■ Deleting the phone number entries in the unit

1 Display the preset list/phone book/call list you want to delete. (☞ page 57)

2

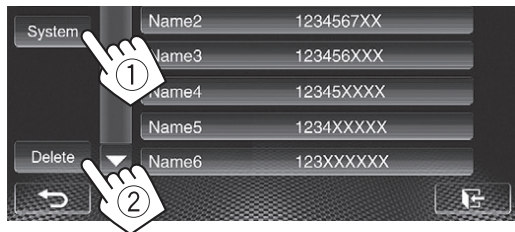

- You cannot delete data when [Phone] is selected.

3 Select the item you want to delete.



Deletes all the numbers/names in the selected list

A confirmation message appears. Press [Yes].

About mobile phones compatible with Phone Book Access Profile (PBAP)

If your mobile phone supports PBAP, you can display the phone book and call lists on the touch panel screen when the mobile phone is connected.

- Phone book: up to 5 000 entries
- Dialed calls, received calls, and missed calls: up to 50 entries each

To display the phone book/call lists of the mobile phone or the unit

Connected mobile phone

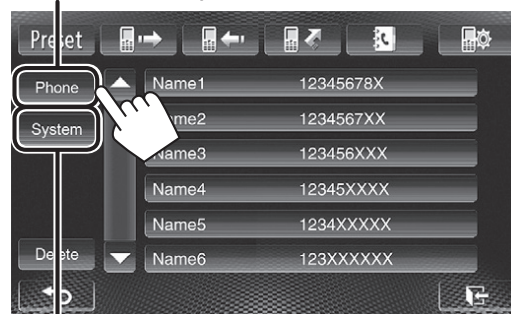

This unit

Settings for Bluetooth mobile phones

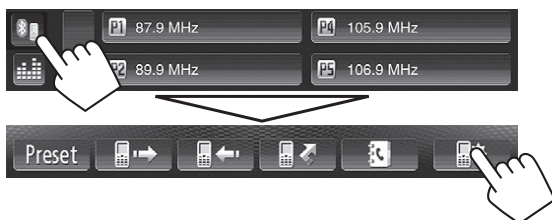

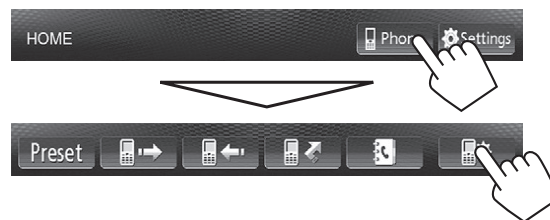

or



Menu items	Selectable setting/item	Initial: <u>Underlined</u>
Auto Answer	<ul style="list-style-type: none"> ◆ <u>On</u> : The unit answers the incoming calls automatically. ◆ <u>Off</u> : The unit does not answer the calls automatically. Answer the calls manually. 	
SMS Notify	<ul style="list-style-type: none"> ◆ <u>On</u> : The unit informs you of the arrival of a message by ringing and displaying "Receiving Message." ◆ <u>Off</u> : The unit does not inform you of the arrival of a message. 	
Ring Mode	<ul style="list-style-type: none"> ◆ <u>System</u> : The ring tone set on the unit is used. ◆ <u>Phone</u> : The ring tone set on the mobile phone is used. (This function may not work depending on the mobile phone.) 	
Ring Tone Change	<p>When <Ring Mode> is set to <System>, press [Enter], then select the ring tone for received calls and SMS from <Tone1>, <Tone2>, <Tone3>.</p> <ul style="list-style-type: none"> ◆ Call Tone : Selects the ring tone for phone calls. ◆ Message Tone : Selects the ring tone for SMS. 	

Using the Bluetooth audio player

- To register a new device,  page 52.
- To connect/disconnect a device,  page 53.

Status of the device/Battery reminder

(only when the information comes

from the device)

Playback mode*¹ ( below)

Track no./Playing time*¹

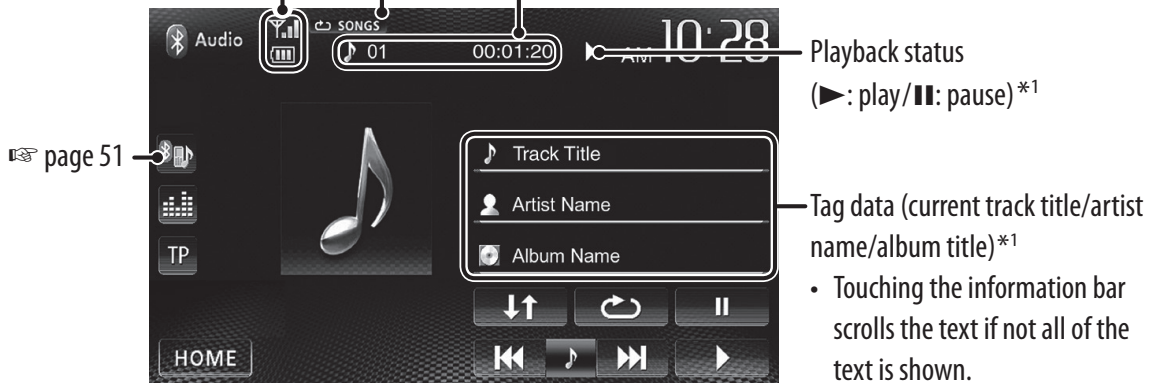

- The operation buttons, indications and information displayed on the screen differ depending on the connected device.

[⏸] Pauses playback.

[↺] Selects Repeat playback mode.*¹*²

[↕] Selects Random playback mode.*¹*²

[▶] Starts playback.

[◀◀] [▶▶] • Selects a track. (Press)

• Reverse/forward search. (Hold)

[HOME] Displays the <HOME> screen.

*¹ Available only for the devices compatible with AVRCP 1.3.

*² To cancel random and repeat mode, press the button repeatedly until the indicator disappears.

Bluetooth operations for KW-AV61

For Bluetooth operations, it is required to connect the Bluetooth adapter, KS-BTA100 (separately purchased) to the LINE IN terminals on the rear of the unit. (☞ Installation/Connection Manual)

- KS-BTA100 is not available in some countries. Please contact your dealer where you purchased this unit.
- For details, refer also to the instructions supplied with the Bluetooth adapter and the Bluetooth device.
- Operations may be different according to the connected device.





■ Preparation

1 Register (pair) a Bluetooth device with KS-BTA100.

- Refer to the instructions manual supplied with KS-BTA100.

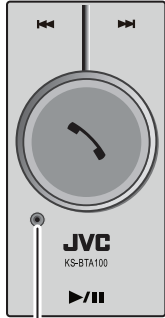
2 Select [BT] for <AV Input>. (☞ page 47)

Using the Bluetooth mobile phone



 <p>KS-BTA100</p> <p>Microphone</p>	 <p>(Low) (High)</p>	Adjusting the microphone volume Volume level: High/Normal (initial)/Low
	 <p>(Press)</p>	<ul style="list-style-type: none"> • Receiving a call When a call comes in... • Making a call Making a call to the last connected number from your phone. • Switching between handsfree and phone While talking...
	 <p>(Hold)</p>	<ul style="list-style-type: none"> • Ends/rejects call • Voice dialing Voice dialing is available only when the connected mobile phone has the voice recognition system.

About microphone volume:

- When you turn off the power of the unit, the volume level changes to Normal.

Using the Bluetooth audio player

1 Select "Bluetooth" as the source. (☞ page 12)

 <p>KS-BTA100</p>		Starts/pauses playback. <ul style="list-style-type: none"> • If playback does not start, operate the Bluetooth audio player to start playback.
		<ul style="list-style-type: none"> • Selects a track. (Press) • Fast-forwards or reverses the track. (Hold)

REFERENCE

Using the remote controller

For KW-AV61BT Region 1/KW-AV61 Region 1: To use the remote controller, purchase RM-RK252P separately.

Installing the batteries

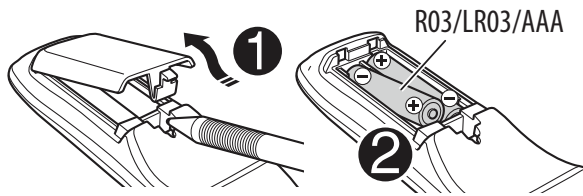

Insert the batteries into the remote controller by matching the polarity (+ and -) correctly.

Caution:

- Danger of explosion if battery is incorrectly replaced. Replace only with the same or equivalent type.
- Battery shall not be exposed to excessive heat such as sunshine, fire, or the like.

If the effectiveness of the remote controller decreases, replace the batteries.

Before using the remote controller:

- Aim the remote controller directly at the remote sensor on the unit.
- DO NOT expose the remote sensor to bright light (direct sunlight or artificial lighting).









The unit is equipped with the steering wheel remote control function.

- See the Installation/Connection Manual (separate volume) for connection.
- Operations may differ depending on the types of the steering wheel remote control.

Operations using the remote controller (RM-RK256)

Button	Operations
ATT	Attenuates/restores the sound.
DISP	Does not function for this unit.
▲ / ▼	<ul style="list-style-type: none"> • Tuner/SiriusXM radio *1: Selects the preset stations. • Selects a title/item/folder.

Button	Operations
	<ul style="list-style-type: none"> • Tuner: <ul style="list-style-type: none"> – Searches for stations automatically. – Searches for stations manually. (Hold) • SiriusXM radio*1 : <ul style="list-style-type: none"> – Selects a channel. – Selects a channel rapidly. (Hold) • Selects a track. • Reverse search/forward search. (Hold)
	<ul style="list-style-type: none"> • Reverse search/forward search. • DVD-Video/DVD-VR/VCD: Slow motion playback (during pause). <ul style="list-style-type: none"> – DVD-VR/VCD: Reverse slow motion does not work.

Button	Operations
VOL +/VOL -	<ul style="list-style-type: none"> Adjusts the volume level. "2nd VOL" function does not work for this unit.
SOURCE	Selects the source.
▶/	Starts/pauses* ² playback.
PHONE / 	Answers incoming calls.* ²
BAND /  / 	<ul style="list-style-type: none"> Selects the bands. Stops playback. Ends the call. Pauses playback of Bluetooth audio.*³
0 - 9 ( page 64)	<ul style="list-style-type: none"> Enters a number while holding SHIFT. The "SETUP" function does not work for this unit.
1 - 6	Enters preset station number while holding SHIFT.
ASPECT	<p>Changes the aspect ratio.</p> <ul style="list-style-type: none"> To check the current aspect ratio setting, operate on the touch panel. ( page 44)
RETURN	Returns to the previous screen.
TOP M ( page 64)	<ul style="list-style-type: none"> DVD-Video: Shows the disc menu. DVD-VR: Shows the Original Program screen. VCD: Resumes PBC playback.
MENU ( page 64)	<ul style="list-style-type: none"> DVD-Video: Shows the disc menu. DVD-VR: Shows the Playlist screen. VCD: Resumes PBC playback.
	<ul style="list-style-type: none"> DVD-Video: Makes selection/settings. DivX*¹: Skips back or forward by about 5 minutes.

Button	Operations
ENT	Confirms selection.
OSD/*	Does not function for this unit.
DUAL/#	Does not function for this unit.
SHIFT	Functions with other buttons.
DIRECT/CLR	<ul style="list-style-type: none"> Enters direct search mode when pressed with SHIFT button. ( page 64) Erases the misentry when pressed with SHIFT button. "SURROUND" function does not work for this unit.

*¹ Only for KW-ADV65BT/KW-AV61BT Region 1/KW-AV61 Region 1.

*² Does not work while listening to Bluetooth audio.

*³ Only for KW-ADV65BT/KW-AV61BT.

Searching for an item directly

Tuner frequency

- 1 Press DIRECT while holding SHIFT to enter the search mode.
- 2 Press number buttons while holding SHIFT to enter a frequency.
 - To erase a misentry, press CLR (clear) while holding SHIFT.
- 3 Press ENT to confirm the entry.

DVD-Video/DVD-VR/DivX/MPEG1/MPEG2/JPEG/MP3/WMA/WAV/VCD/CD

- 1 Press DIRECT while holding SHIFT to enter the search mode.
 - Each time you press DIRECT, the item to search for changes.
- 2 Press a number button while holding SHIFT to select a desired item.
 - To erase a misentry, press CLR (clear) while holding SHIFT.
- 3 Press ENT to confirm the selection.

Various disc operations

Using the disc menu

• **DVD-Video/DVD-VR**

- 1 For DVD Video, press TOP M or MENU.
For DVD-VR, press...
 - TOP M: To display Original Program
 - MENU: To display Playlist
- 2 Press $\triangle/\nabla/\leftarrow/\rightarrow$ to select an item you want to play.
- 3 Press ENT to confirm the selection.

• **VCD**

During PBC playback...

- 1 Press DIRECT while holding SHIFT to enter the search mode.
- 2 Press a number button while holding SHIFT to select the item you want to play.
- 3 Press ENT to confirm the selection.

- To return to the previous screen, press RETURN.

To cancel PBC playback

- 1 Press \blacksquare to stop PBC playback.
- 2 Press DIRECT while holding SHIFT.
- 3 Press a number button while holding SHIFT to select a desired track.
- 4 Press ENT to confirm the selection.

- To resume PBC, press TOP M or MENU.

Maintenance

Caution on cleaning the unit

Do not use any solvent (for example, thinner, benzene, etc.), detergent, or insecticide. This may damage the monitor or the unit.

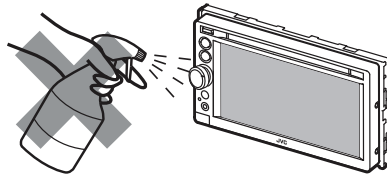

Recommended cleaning method:

Gently wipe the panel with a soft, dry cloth.

How to clean the connector

Frequent detachment will deteriorate the connectors.

To minimize this possibility, periodically wipe the connectors with a cotton swab or cloth moistened with alcohol, being careful not to damage the connectors.

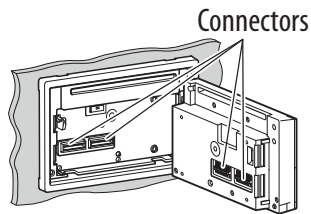

Moisture condensation

Moisture may condense on the lens inside the unit in the following cases:

- After starting the heater in the car.
- If it becomes very humid inside the car.

Should this occur, the unit may malfunction. In this case, eject the disc and leave the unit turned on for a few hours until the moisture evaporates.

How to handle discs

When removing a disc from its case, press down the center holder of the case and lift the disc out, holding it by the edges.



- Always hold the disc by the edges. Do not touch its recording surface.

When storing a disc in its case, gently insert the disc around the center holder (with the printed surface facing up).

- Make sure to store discs in their cases after use.

To keep discs clean

A dirty disc may not play correctly.

If a disc does become dirty, wipe it with a soft cloth in a straight line from center to edge.



- Do not use any solvents (for example, conventional record cleaner, spray, thinner, benzene, etc.) to clean discs.

To play new discs

New discs may have some rough spots around the inner and outer edges. If such a disc is used, this unit may reject the disc.

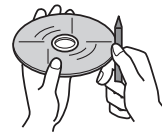

To remove these rough spots, rub the edges with a pencil or ball-point pen, etc.

Do not use the following discs:

3 inch disc



Warped disc



Sticker and sticker residue

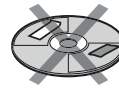

Stick-on label



Unusual shape



C-thru Disc (semi-transparent disc)

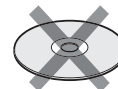

Transparent or semi-transparent parts on its recording area

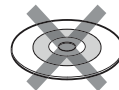

More about this unit

■ File playback

Playing DivX files (for discs only/for KW-ADV65BT/KW-AV61BT Region 1/KW-AV61 Region 1 only)

- This unit can play back DivX files with the extension code <.divx>, <.div>, or <.avi> (regardless of the letter case—upper/lower).
- Audio stream should conform to MP3 or Dolby Digital.
- The file encoded in the interlaced scanning mode may not be played back correctly.
- The maximum bit rate for video signals (average) is 4 Mbps.

Playing MPEG1/MPEG2 files

- This unit can play back MPEG1/MPEG2 files with the extension code <.mpg>, <.mpeg>, or <.mod>.
- The stream format should conform to MPEG system/program stream.
The file format should be MP@ML (Main Profile at Main Level)/SP@ML (Simple Profile at Main Level)/MP@LL (Main Profile at Low Level).
- Audio streams should conform to MPEG1 Audio Layer-2 or Dolby Digital.
- The maximum bit rate for video signals (average) is 4 Mbps.

Playing JPEG files

- This unit can play back JPEG files with the extension code <.jpg> or <.jpeg>.
- This unit can play back JPEG files that are at 32 x 32 to 8 192 x 7 680 resolution.
It may take time to display the file depending on its resolution.
- This unit can play back baseline JPEG files.
Progressive JPEG files or lossless JPEG files cannot be played.

Playing MP3/WMA/WAV files

- This unit can play back files with the extension code <.mp3>, <.wma>, or <.wav> (regardless of the letter case—upper/lower).
- This unit can play back the files meeting the conditions below:
 - Bit rate:
MP3/WMA: 32 kbps — 320 kbps
 - Sampling frequency:
48 kHz, 44.1 kHz, 32 kHz (for MPEG1)
24 kHz, 22.05 kHz, 16 kHz (for MPEG2)
48 kHz, 44.1 kHz, 32 kHz, 22.05 kHz (for WMA)
44.1 kHz (for WAV)
- This unit can show ID3 Tag Version
1.0/1.1/2.2/2.3/2.4 (for MP3).
- This unit can also show WAV/WMA Tag.
- This unit can play back files recorded in VBR (variable bit rate).
- Files recorded in VBR have a discrepancy in elapsed time indication.
- This unit cannot play back the following files:
 - MP3 files encoded with MP3i and MP3 PRO format.
 - MP3 files encoded with Layer 1/2.
 - WMA files encoded with lossless, professional, and voice format.
 - WMA files which are not based upon Windows Media® Audio.
 - WMA files copy-protected with DRM.
- This unit can display the jacket picture meeting the conditions below:
 - Picture size: 32 x 32 to 1 232 x 672 resolution
 - Data size: less than 650 KB.
 - File type: JPEG

We bear no responsibility for any loss of data in an iPod/iPhone and USB mass storage class device while using this unit.

■ Sound signals emitted through the rear terminals

Through the analog terminals (Speaker out/REAR OUT/FRONT OUT)

2-channel signal is emitted. When playing multi-channel encoded disc, multi-channel signals are downmixed.

■ Language codes (for DVD/DVD-VR language selection)

Code	Language	Code	Language	Code	Language	Code	Language
AA	Afar	GL	Galician	MI	Maori	SO	Somali
AB	Abkhazian	GN	Guarani	MK	Macedonian	SQ	Albanian
AF	Afrikaans	GU	Gujarati	ML	Malayalam	SR	Serbian
AM	Ameharic	HA	Hausa	MN	Mongolian	SS	Siswati
AR	Arabic	HI	Hindi	MO	Moldavian	ST	Sesotho
AS	Assamese	HR	Croatian	MR	Marathi	SU	Sundanese
AY	Aymara	HU	Hungarian	MS	Malay (MAY)	SW	Swahili
AZ	Azerbaijani	HY	Armenian	MT	Maltese	TA	Tamil
BA	Bashkir	IA	Interlingua	MY	Burmese	TE	Telugu
BE	Byelorussian	IE	Interlingue	NA	Nauru	TG	Tajik
BG	Bulgarian	IK	Inupiak	NE	Nepali	TH	Thai
BH	Bihari	IN	Indonesian	NO	Norwegian	TI	Tigrinya
BI	Bislama	IS	Icelandic	OC	Occitan	TK	Turkmen
BN	Bengali, Bangla	IW	Hebrew	OM	(Afan) Oromo	TL	Tagalog
BO	Tibetan	JA	Japanese	OR	Oriya	TN	Setswana
BR	Breton	JI	Yiddish	PA	Panjabi	TO	Tonga
CA	Catalan	JW	Javanese	PL	Polish	TR	Turkish
CO	Corsican	KA	Georgian	PS	Pashto, Pushto	TS	Tsonga
CS	Czech	KK	Kazakh	QU	Quechua	TT	Tatar
CY	Welsh	KL	Greenlandic	RM	Rhaeto-Romance	TW	Twi
DZ	Bhutani	KM	Cambodian	RN	Kirundi	UK	Ukrainian
EL	Greek	KN	Kannada	RO	Rumanian	UR	Urdu
EO	Esperanto	KO	Korean (KOR)	RW	Kinyarwanda	UZ	Uzbek
ET	Estonian	KS	Kashmiri	SA	Sanskrit	VI	Vietnamese
EU	Basque	KU	Kurdish	SD	Sindhi	VO	Volapuk
FA	Persian	KY	Kirghiz	SG	Sangho	WO	Wolof
FI	Finnish	LA	Latin	SH	Serbo-Croatian	XH	Xhosa
FJ	Fiji	LN	Lingala	SI	Singhalese	YO	Yoruba
FO	Faroese	LO	Laothian	SK	Slovak	ZU	Zulu
FY	Frisian	LT	Lithuanian	SL	Slovenian		
GA	Irish	LV	Latvian, Lettish	SM	Samoan		
GD	Scots Gaelic	MG	Malagasy	SN	Shona		

- Manufactured under license from Dolby Laboratories. Dolby and the double-D symbol are trademarks of Dolby Laboratories.
- “DVD Logo” is a trademark of DVD Format/Logo Licensing Corporation registered in the US, Japan and other countries.
- Microsoft and Windows Media are either registered trademarks or trademarks of Microsoft Corporation in the United States and/or other countries.
- “Made for iPod,” and “Made for iPhone” mean that an electronic accessory has been designed to connect specifically to iPod, or iPhone, respectively, and has been certified by the developer to meet Apple performance standards. Apple is not responsible for the operation of this device or its compliance with safety and regulatory standards. Please note that the use of this accessory with iPod, or iPhone may affect wireless performance. iPhone, iPod, iPod classic, iPod nano, and iPod touch are trademarks of Apple Inc., registered in the U.S. and other countries.
- This item incorporates copy protection technology that is protected by U.S. patents and other intellectual property rights of Rovi Corporation. Reverse engineering and disassembly are prohibited.
- Font for this product is designed by Ricoh.

Only for KW-ADV65BT/KW-AV61BT Region 1/KW-AV61 Region 1

- DivX[®], DivX Certified[®] and associated logos are trademarks of Rovi Corporation or its subsidiaries and are used under license.
ABOUT DIVX VIDEO: DivX[®] is a digital video format created by DivX, LLC, a subsidiary of Rovi Corporation. This is an official DivX Certified[®] device that plays DivX video. Visit divx.com for more information and software tools to convert your files into DivX videos.
ABOUT DIVX VIDEO-ON-DEMAND: This DivX Certified[®] device must be registered in order to play purchased DivX Video-on-Demand (VOD) movies. To obtain your registration code, locate the DivX VOD section in your device setup menu. Go to vod.divx.com for more information on how to complete your registration.
- Pandora, the Pandora logo, and the Pandora trade dress are trademarks or registered trademarks of Pandora Media, Inc., used with permission.
- Sirius, XM and all related marks and logos are trademarks of Sirius XM Radio Inc. All rights reserved.
- Android is a trademark of Google Inc.
- BlackBerry[®], RIM[®], Research In Motion[®] and related trademarks, names and logos are the property of Research In Motion Limited and are registered and/or used in the U.S. and countries around the world. Used under license from Research In Motion Limited.

Only for KW-ADV65BT/KW-AV61BT

- The Bluetooth[®] word mark and logos are registered trademarks owned by Bluetooth SIG, Inc. and any use of such marks by JVC KENWOOD Corporation is under license. Other trademarks and trade names are those of their respective owners.

Troubleshooting

What appears to be trouble is not always serious. Check the following points before calling a service center.

- For operations with the external components, refer also to the instructions supplied with the adapters used for the connections (as well as the instructions supplied with the external components).

If the following messages appear

Message	Remedy/Cause
"No Signal"	<ul style="list-style-type: none"> • Start the playback on the external component connected to VIDEO IN jack. • Check the cords and connections. • Signal input is too weak.
"MISWIRING Check wiring connection then reset unit" "WARNING Check wiring connection then reset unit"	A speaker cord has shorted or it has come in to contact with the car chassis. Wire or insulate the speaker cord as appropriate, then reset the unit (👉 page 3). See also the Installation/Connection Manual.
"Parking Brake"	No playback picture is shown when the parking brake is not engaged.
"Eject Error" / "Loading Error"	Eject the disc forcibly. (👉 page 3)
"Restricted Device"	Check whether the connected iPod/iPhone is compatible with this unit. (👉 page 26)
"USB Device Error"	<ul style="list-style-type: none"> • The USB power voltage is abnormal. • Turn off and turn on the unit. • Connect another USB device.
"No BT Dongle"*1	The Bluetooth adapter (KS-UBT1) is removed.
"Connection Error"*1	The device is registered but the connection has failed. Connect the registered device. (👉 page 53)
"Please Wait..."*1	The unit is preparing to use the Bluetooth function. If the message does not disappear, turn off and turn on the unit, then connect the device again (or reset the unit).
"No Voice Device"*1	The connected mobile phone does not have the voice recognition system.
"No Data"*1	No phone book data is contained in the connected Bluetooth phone.
"Initialize Error"*1	The unit has failed to initialize the Bluetooth module. Try the operation again.
"Dial Error"*1	Dialing has failed. Try the operation again.
"Hung Up Error"*1	The call has not ended yet. Park your car, and use the connected mobile phone to end the call.
"Pick Up Error"*1	The unit has failed to receive a call.
"Pairing Error"*1	Pairing between the unit and Bluetooth device has failed. Register the device again. (👉 page 52)
"Pandora upgrade required"*2	The Pandora application on your iPhone/iPod touch/Android/BlackBerry is not the latest version. Update the application.

*1 Only for KW-ADV65BT/KW-AV61BT.

*2 Only for KW-ADV65BT/KW-AV61BT Region 1/KW-AV61 Region 1.

If there seems to be a problem

	Symptom	Remedy/Cause
General	No sound comes out of the speakers.	<ul style="list-style-type: none"> Adjust the volume to the optimum level. Check the cords and connections.
	No picture is displayed on the screen.	Turn on the screen. (☞ page 9)
	The unit does not work at all.	Reset the unit. (☞ page 3)
	The remote controller* ¹ does not work.	Replace the battery.
	The desired source button ([Bluetooth]* ² , [AV-IN], or [Apps]) is not displayed on the <HOME> screen.	Select an appropriate setting for <AV Input>. (☞ page 47)
	The Apps switch button (☞) on the source control screen or [Apps] button on the <HOME> screen is not displayed.	Select an appropriate setting for <Navigation Input>. (☞ page 48)
TUNER	SSM automatic presetting does not work.	Store stations manually. (☞ page 15)
	Static noise while listening to the radio.	Connect the antenna firmly.
Disc in general	Disc can be neither recognized nor played back.	Eject the disc forcibly. (☞ page 3)
	Disc cannot be ejected.	Unlock the disc. (☞ page 17)
	<ul style="list-style-type: none"> Recordable/Rewritable discs cannot be played back. Tracks on the Recordable/Rewritable discs cannot be skipped. 	<ul style="list-style-type: none"> Insert a finalized disc. Finalize the discs with the component which you used for recording.
	Playback does not start.	The format of files is not supported by the unit.
	No picture appears on the external monitor.	<ul style="list-style-type: none"> Connect the video cord correctly. Select the correct input on the external monitor.
DivX/MPEG1/MPEG2/ JPEG/MP3/WMA/WAV	Disc cannot be played back.	<ul style="list-style-type: none"> Record the tracks using a compliant application on the appropriate discs. (☞ page 18) Add appropriate extension codes to the file names.
	Tracks are not played back as you have intended them to play.	Playback order may differ from the one played back using other players.

*¹ For KW-AV61BT Region 1/KW-AV61 Region 1: Purchase RM-RK252P separately.

*² Only for KW-AV61.

	Symptom	Remedy/Cause
USB	“Now Reading...” does not disappear from the screen.	Turn off the power and on again.
	While playing a track, sound is sometimes interrupted.	The tracks are not properly copied into the USB device. Copy tracks again, and try again.
iPod/iPhone	No sound comes out of the speakers.	<ul style="list-style-type: none"> • Disconnect the iPod, then connect it again. • Select another source, then reselect “iPod”.
	The iPod/iPhone does not turn on or does not work.	<ul style="list-style-type: none"> • Check the connecting cable and its connection. • Update the firmware version. • Charge the battery. • Check whether the iPod control mode is correctly selected. (☞ page 27) • Reset the iPod/iPhone.
	Sound is distorted.	Deactivate the equalizer either on this unit or the iPod/iPhone.
	A lot of noise is generated.	Turn off (uncheck) “VoiceOver” of the iPod. For details, visit < http://www.apple.com >.
	No operations are available when playing back a track containing Artwork.	Operate the unit after the Artwork is loaded.
	Sound does not synchronize with the video.	Select [iPod] for <AV Input>. (☞ page 47)
AV-IN	<ul style="list-style-type: none"> • Videos cannot be played. • No sound of videos come out. 	<ul style="list-style-type: none"> • Connect with USB Audio and Video cable JVC KS-U30. Other cables cannot be used. • Select [iPod] for <AV Input>. (☞ page 47)
	No picture appears on the screen.	<ul style="list-style-type: none"> • Turn on the video component if it is not on. • Connect the video component correctly.
Pandora	The Pandora application does not work.	The Pandora application on your iPhone/iPod touch/Android/BlackBerry is not the latest version. Update the application.

	Symptom	Remedy/Cause
SiriusXM™ radio (only for KW-ADV65BT/KW-AV61BT Region 1/KW-AV61 Region 1)	"No Signal" appears on the screen.	Make sure the SiriusXM radio antenna is mounted outside the vehicle. Move vehicle to an area with a clear view of the sky.
	"Check Antenna" appears on the screen.	<ul style="list-style-type: none"> • Check the SiriusXM radio antenna connection, and make sure the antenna is firmly attached to the tuner. • Check whether the SiriusXM radio antenna cable is bent or broken. If it is damaged, replace the whole antenna unit.
	"Check Tuner" appears on the screen.	Make sure the SiriusXM tuner is connected to the unit.
	"Chan Unavailable" appears on the screen for about 2 seconds, then returns to the previous channel.	Selected channel is no longer available or is unauthorized. Select another channel or continue listening to the previous channel.
	"Ch Unsubscribed" appears on the screen.	Selected channel is not part of your current subscription plan. Call 1-866-635-2349 to subscribe.
	"Subscription Updated – Press Enter to Continue" appears on the screen.	Your subscription is updated. Press the appropriate button to continue.
	"Channel Locked" appears on the screen.	The selected channel has been locked by the parental controls. Enter unlock code after you are asked. (👉 page 38)
	"Incorrect Lock Code" appears on the screen.	The selected channel is a mature or parental lock channel, and locked by parental lock or user lock code. Enter the correct lock code.

	Symptom	Remedy/Cause
Bluetooth (only for KW-ADV65BT/KW-AV61BT)	Phone sound quality is poor.	<ul style="list-style-type: none"> • Reduce the distance between the unit and the Bluetooth mobile phone. • Move the car to place where you can get a better signal reception.
	The sound is interrupted or skipped while using a Bluetooth audio player.	<ul style="list-style-type: none"> • Reduce the distance between the unit and the Bluetooth audio player. • Disconnect the device connected for Bluetooth phone. • Turn off, then turn on the unit. • (When the sound is not yet restored) connect the player again.
	The connected audio player cannot be controlled.	Check whether the connected audio player supports AVRCP (Audio Video Remote Control Profile).
	Bluetooth device does not detect the unit.	<ul style="list-style-type: none"> • Check whether the Bluetooth adapter (KS-UBT1) is inserted correctly. • Search from the Bluetooth device again.
	The unit does not make pairing with the Bluetooth device.	<ul style="list-style-type: none"> • For devices compatible with Bluetooth 2.1: Register the device using a PIN code. (☞ page 52) • For devices compatible with Bluetooth 2.0: Enter the same PIN code for both the unit and target device. If the PIN code of the device is not indicated on its instructions, try "0000" or "1234."
	Echo or noise occurs.	<ul style="list-style-type: none"> • Adjust the microphone unit position. • Make sure that the NR/EC (Noise reduction/Echo cancel) function is activated. Adjust the echo level if necessary (☞ page 56)
	The unit does not respond when you try to copy the phone book to the unit.	You may have tried to copy the same entries (as stored) to the unit.

Specifications

AMPLIFIER	Power Output	20 W RMS × 4 Channels at 4 Ω and ≤ 1% THD+N		
	Signal-to-Noise Ratio	80 dBA (reference: 1 W into 4 Ω)		
	Load Impedance	4 Ω (4 Ω to 8 Ω allowance)		
	Equalizer Control Range	Frequencies	Low: 60 Hz, 80 Hz, 100 Hz, 150 Hz Mid: 500 Hz, 1 kHz, 1.5 kHz, 2 kHz High: 10 kHz, 12.5 kHz, 15 kHz, 17.5 kHz	
		Level	±10 dB	
	Audio Output Level LINE OUT (FRONT/REAR), SUBWOOFER	Line-Out Level/Impedance	4 V/20 kΩ load (full scale)	
		Output Impedance	1 kΩ	
	Other Terminals	Input	LINE IN, VIDEO IN, CAMERA IN, USB input, MIC IN* ¹ , AUX, Antenna input	
Others		Expansion port (SXi* ²), OE REMOTE		
FM/AM TUNER	Frequency Range	FM	with channel interval set to 200 kHz	87.9 MHz to 107.9 MHz
			with channel interval set to 50 kHz	87.5 MHz to 108.0 MHz
		AM		530 kHz to 1 700 kHz
	FM Tuner	Usable Sensitivity	9.3 dBf (0.8 μV/75 Ω)	
		50 dB Quieting Sensitivity	16.3 dBf (1.8 μV/75 Ω)	
		Alternate Channel Selectivity (400 kHz)	65 dB	
		Frequency Response	40 Hz to 15 000 Hz	
		Stereo Separation	40 dB	
AM Tuner	Sensitivity/Selectivity	20 μV/40 dB		
DVD/CD	Signal Detection System	Non-contact optical pickup (semiconductor laser)		
	Frequency Response	DVD, fs=48 kHz/96 kHz	16 Hz to 22 000 Hz	
		VCD/CD	16 Hz to 20 000 Hz	
	Dynamic Range	93 dB		
	Signal-to-Noise Ratio	95 dB		
	Wow and Flutter	Less than measurable limit		
	Color System	NTSC/PAL		
Video-Out (composite)	1 Vp-p/75 Ω			

*¹ Only for KW-ADV65BT/KW-AV61BT.

*² Only for Region 1 models.

USB	USB Standards	USB 2.0 Full Speed		
	Data Transfer Rate	Full Speed	Maximum 12 Mbps	
		Low Speed	Maximum 1.5 Mbps	
	Compatible Device	Mass storage class		
	Compatible File System	FAT 32/16/12		
Max. Current	DC 5 V $\overline{=}$ 1 A			
BLUETOOTH*	Version	Bluetooth 2.1+EDR certified		
	Output Power	+4 dBm Max. (Power class 2)		
	Service Area	Within 10 m (10.9 yd)		
	Profile	HFP (Hands-Free Profile) 1.5 OPP (Object Push Profile) 1.1 A2DP (Advanced Audio Distribution Profile) 1.2 AVRCP (Audio/Video Remote Control Profile) 1.3 PBAP (Phone Book Access Profile) 1.0 SPP (Serial Port Profile)		
MONITOR	Screen Size	6.1 inch wide liquid crystal display		
	Number of Pixel	1 152 000 pixels: 800 (horizontal) \times 3 (RGB) \times 480 (vertical)		
	Drive Method	TFT (Thin Film Transistor) active matrix format		
	Color System	NTSC/PAL		
	Aspect Ratio	16:9 (wide)		
GENERAL	Power Requirement	Operating Voltage	DC 14.4 V (11 V to 16 V allowance)	
	Grounding System		Negative ground	
	Allowable Storage Temperature		-10°C to +60°C (14°F to 140°F)	
	Allowable Operating Temperature		0°C to +40°C (32°F to 104°F)	
	Dimensions (W \times H \times D)	Installation Size (approx.)	182 mm \times 111 mm \times 160 mm (7-3/16" \times 4-3/8" \times 6-5/16")	
		Panel Size (approx.)	188 mm \times 117 mm \times 10 mm (7-7/16" \times 4-5/8" \times 7/16")	
	Mass (approx.)		2.3 kg (5.1 lbs) (including the Trim plate and Mounting sleeve)	

* Only for KW-ADV65BT/KW-AV61BT.

Design and specifications are subject to change without notice.

If a kit is necessary for your car, consult your telephone directory for the nearest car audio speciality shop.



■ The countries where you may use the Bluetooth® function (For KS-UBT1)

- Die Länder, in denen Sie die Bluetooth® Funktion verwenden können
- Pays où vous pouvez utiliser la fonction Bluetooth®
- De landen waar u de Bluetooth®-functie mag gebruiken
- Países en los que se puede utilizar la función Bluetooth®
- Paesi nei quali è possibile utilizzare la funzione Bluetooth®
- Länder där du kan använda Bluetooth®-funktionen
- Lande, hvor du kan bruge Bluetooth®-funktionen
- Land hvor du kan bruke Bluetooth®-funksjonen
- Maat, joissa voi käyttää Bluetooth®-toimintoa
- Países onde pode usar a função Bluetooth®
- Países onde você pode usar a função Bluetooth®
- Οι χώρες όπου μπορείτε να χρησιμοποιήσετε τη λειτουργία Bluetooth®
- Страны, где можно воспользоваться функцией Bluetooth®
- Země, ve kterých můžete využívat funkci Bluetooth®
- Azok az országok, amelyekben használhatjuk a Bluetooth®-funkciót
- Kraje, w których można używać funkcji Bluetooth®
- Države, kjer lahko uporabljate funkcijo Bluetooth®
- Krajiny, v ktorých môžete využívať funkciu Bluetooth®
- Valstis, kur jūs varat izmantot Bluetooth® funkciju
- Šalys, kuriose galite naudotis „Bluetooth®“ funkcija
- Il-pajjizi fejn tista' tuża l-funzjoni Bluetooth®
- Lönd þar sem hægt er að nota Bluetooth®
- Riigid, kus on võimalik kasutada Bluetooth® funktsiooni
- Bluetooth® fonksiyonunu kullanabileceğiniz ülkeler
- ประเทศที่ท่านสามารถใช้ Bluetooth® ฟังก์ชัน
- Na tíortha inar féidir leat feidhmiú Bluetooth® a úsáid
- Länner an denen der d'Bluetooth® Funktioun benotze kënnt.
- Ở những quốc gia mà bạn có thể sử dụng chức năng Bluetooth®
- Els països on podrà fer servir la funció Bluetooth®
- Zemlje u kojima je dozvoljena upotreba Bluetooth® funkcije.
- Zemlje u kojima možete koristiti Bluetooth® funkciju
- Zemlje u kojima je dopušteno koristiti Bluetooth®.
- Земљи каде можете да ја користите функцијата Bluetooth®
- Страните, в които можете да ползвате функцията Bluetooth®
- Țările în care puteți utiliza funcția Bluetooth®
- Die lande waar u die Bluetooth®-funksie kan gebruik
- Amazwe lapho ungasebenzisa khona uhlelo lwe-Bluetooth®
- Ang mga bansa kung saan maaari kang gumamit ng Bluetooth® function
- Negara-negara yang membolehkan penggunaan fungsi Bluetooth®
- Negara-negara yang anda boleh menggunakan fungsi Bluetooth®
- वे देश जहाँ आप Bluetooth® कार्य-क्षमता का उपयोग कर सकते हैं
- 您能够使用 Bluetooth® 功能的国家
- 您能夠使用 Bluetooth® 功能的國家
- Bluetooth® 기능을 사용할 수 있는 국가
- الدول التي يمكنك استخدامها وظيفة Bluetooth® فيها

Country
Andorra
الإمارات العربية المتحدة
Australia
Österreich
Bosna i Hercegovina
Belgien Belgique
България
Brasil
Canada
Schweiz Suisse
Chile
Κύπρος Kıbrıs
Česká republika
Deutschland
Danmark
Eesti
España
Suomi Finland
France
United Kingdom
Ελλάδα
Hong Kong 香港 香港
Hrvatska
Magyarország
Indonesia

Country
Ireland Éire
India भारत
Ísland
Italia
대한민국
Lichtenstein
Lietuva
Luxemburg Luxembourg Lëtzebuerg
Latvija
Monaco
Crna Gora
Македонија
Malta
Malaysia
Nederland
Norge
New Zealand
Perú
Philippines Pilipinas
Polska
Portugal
República Oriental del Uruguay
România
Srbija
Россия

Country
Sverige
Singapore 新加坡 Singapura
Slovenija
Slovensko
ประเทศไทย
Türkiye
台灣
United States of America
Venezuela
Vietnam Việt Nam
South Africa ENingizimu Afrika Suid-Afrika



Having TROUBLE with operation?

Please reset your unit

Refer to page of How to reset your unit

Still having trouble??

USA ONLY

Call 1-800-252-5722

<http://www.jvc.com>

We can help you!

JVC



EN, SP, FR

© 2012 JVC KENWOOD Corporation

1112EHHMDWJEIN

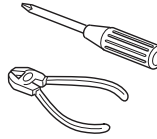

GET0884-003A
[J/JW]

1112EHHMDWJEIN
EN, SP, FR

© 2012 JVC KENWOOD Corporation

ENGLISH

This installation/connection manual is used to describe models listed below.

- Region 1 (DVD Region Code 1 area)
- Region 4 (DVD Region Code 4 area)

This unit is designed to operate on **12 V DC, NEGATIVE ground electrical systems**. If your vehicle does not have this system, a voltage inverter is required, which can be purchased at JVC car audio dealers.

WARNINGS

- DO NOT install any unit or wire any cable in a location where;
 - it may obstruct the steering wheel and gearshift lever operations, as this may result in a traffic accident.
 - it may obstruct the operation of safety devices such as air bags, as this may result in a fatal accident.
 - it may obstruct visibility.
- DO NOT operate any unit while manipulating the steering wheel, as this may result in a traffic accident.
- The driver must not watch the monitor while driving. It may lead to carelessness and cause an accident.
- If you need to operate the unit while driving, be sure to look around carefully or you may be involved in a traffic accident.
- If the parking brake is not engaged, "Parking Brake" appears on the monitor, and no playback picture will be shown.

To prevent short circuits, disconnect the battery's negative terminal and make all electrical connections before installing the unit.

- **Be sure to ground this unit to the car's chassis again after installation.**
- Be sure any cable is not caught on the car's chassis or under seats.

Notes on electrical connections:

- Replace the fuse with one of the specified rating. If the fuse blows frequently, consult your JVC car audio dealer.
- It is recommended to connect speakers with maximum power of more than 50 W (both at the rear and at the front, with an impedance of **4 Ω to 8 Ω**).
- To prevent short circuits, cover the terminals of the UNUSED leads with insulating tape.
- At the time of installation, be sure to fix all wires (wires both from this unit and from the car itself) in a way that no wires can come into contact with heat sinks on the rear and side of the unit.

CAUTION: Install this unit in the console of your vehicle. Do not touch the metal parts of this unit during and shortly after the use of the unit. Metal parts such as the heat sink and enclosure become hot.

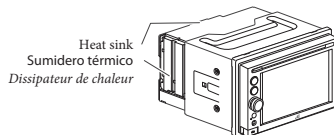

ESPAÑOL

Este manual de instalación/conexión proporciona instrucciones para los modelos indicados a continuación.

- Región 1 (Área del Código de Región 1 de DVD)
- Región 4 (Área del Código de Región 4 de DVD)

Esta unidad está diseñada para funcionar con **12 V de CC, con sistemas eléctricos de masa NEGATIVA**. Si su vehículo no posee este sistema, será necesario un inversor de tensión, que puede ser adquirido en los concesionarios de JVC de equipos de audio para automóviles.

ADVERTENCIAS

- NO instale ningún receptor o tienda ningún cable en una ubicación donde;
 - donde pueda obstruir la maniobra del volante de dirección y del cambio de engranajes, con el consiguiente riesgo de accidentes de tráfico.
 - donde pueda obstruir el funcionamiento de dispositivos de seguridad tales como bolsas de aire, pues podría resultar en un accidente fatal.
 - donde pueda obstruir la visibilidad.
- NO opere la unidad mientras está maniobrando el volante de dirección, pues podría producirse un accidente de tráfico.
- El conductor no debe mirar el monitor mientras conduce. Podría producirse un descuido, y causar un accidente.
- Si necesita operar la unidad mientras conduce, asegúrese de mirar atentamente a su alrededor pues de lo contrario, se podría producir un accidente de tráfico.
- Si el freno de mano no está en uso, aparecerá "Parking Brake (Freno de Mano)" en la pantalla y no se mostrará ninguna secuencia de imagen.

Antes de instalar la unidad, desconecte el terminal negativo de la batería y realice todas las conexiones eléctricas para evitar cortocircuitos.

- **Asegúrese de volver a conectar a masa esta unidad al chasis del automóvil después de la instalación.**
- Asegúrese de que ningún cable quede atrapado en el chasis del automóvil o debajo de los asientos.

Notes sobre las conexiones eléctricas:

- Reemplace el fusible por otro del régimen especificado. Si el fusible se funde frecuentemente, consulte con su concesionario de JVC de equipos de audio para automóviles.
- Se recomienda conectar los altavoces con una potencia máxima de más de 50 W (tanto atrás como adelante, con una impedancia de **4 Ω a 8 Ω**).
- Para evitar cortocircuitos, cubra los cables NO UTILIZADOS con cinta aislante.
- Al realizar la instalación, asegúrese de fijar todos los cables (tanto los que proceden de esta unidad como los del vehículo en sí) de manera tal que ninguno quede en contacto con los disipadores térmicos de las partes traseras y laterales de la unidad.

PRECAUCIÓN: Instale esta unidad en la consola de su vehículo. No toque las partes metálicas de esta unidad durante e inmediatamente después de usar la unidad. Las partes metálicas, tales como el disipador de calor y la carcasa estarán calientes.

FRANÇAIS

Ce manuel d'installation/connexion est utilisé pour décrire les modèles de la liste ci-dessous.

- Région 1 (DVD, code de région 1)
- Région 4 (DVD, code de région 4)

Cet appareil est conçu pour fonctionner sur des sources de courant continu de **12 V à masse NEGATIVE**. Si votre véhicule n'offre pas ce type d'alimentation, il vous faut un convertisseur de tension, que vous pouvez acheter chez un revendeur d'autoradios JVC.

AVERTISSEMENTS

- **N'INSTALLEZ aucun appareil ni aucun câble dans un endroit où:**
 - où il peut gêner l'accès au volant ou au levier de vitesse car cela peut entraîner un accident de la circulation.
 - où il peut gêner la manipulation de dispositifs de sécurité tels que les airbags car cela peut entraîner un accident fatal.
 - où il peut gêner la visibilité.
- **NE COMMANDEZ PAS l'appareil lors de la manipulation du volant car cela peut entraîner un accident de la circulation.**
- Le conducteur ne doit pas regarder le moniteur lorsqu'il conduit. Cela peut lui faire perdre sa concentration et causer un accident.
- Si vous souhaitez opérer l'appareil pendant que vous conduisez, assurez-vous de bien regarder autour de vous afin de ne pas causer un accident de la circulation.
- Si le frein à main n'est pas engagé, "Parking Brake (Frein à Main)" s'affiche sur le moniteur et aucune image de lecture n'apparaît.

Pour éviter tout court-circuit, débranchez la borne négative de la batterie et effectuez tous les raccordements électriques avant d'installer l'appareil.

- **Assurez-vous de raccorder de nouveau la mise à la masse de cet appareil au châssis de la voiture après l'installation.**
- Assurez-vous qu'aucun câble n'est coincé sur châssis de la voiture ou sous les sièges.

Remarques sur les connexions électriques:

- Remplacer le fusible par un de la valeur précisée. Si le fusible saute souvent, consultez votre revendeur d'autoradios JVC.
- Il est recommandé de connecter des enceintes avec une puissance de plus de 50 W (les enceintes arrière et les enceintes avant, avec une impédance comprise entre **4 Ω et 8 Ω**).
- Pour éviter les court-circuits, couvrir les bornes des fils qui ne sont PAS UTILISÉS avec de la bande isolante.
- Au moment de l'installation, assurez-vous de fixer tous les fils (les fils de cet appareil et aussi de la voiture elle-même) de façon qu'aucun fil ne puisse entrer en contact avec les dissipateurs de chaleur situés à l'arrière et sur le côté de l'appareil.

ATTENTION : Installez cet appareil dans la console de votre véhicule. Ne touchez pas les parties métalliques de cet appareil pendant ou juste après son utilisation. Les parties métalliques, comme le dissipateur de chaleur et le boîtier, deviennent chaudes.

Parts list for installation and connection

Main unit/Mounting sleeve/Trim plate
Unidad principal/Cubierta de montaje /Placa de guarnición
Appareil principal/Manchon de montage/Plaque d'assemblage

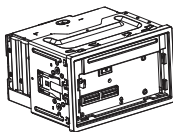

Extension wire
Cable prolongador
Fil d'extension

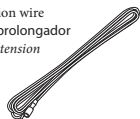

Wiring harness
Mazo de cables
Câblage électrique

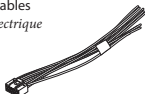

Extraction keys
Llaves de extracción
Clés d'extraction



Monitor panel
Panel del monitor
Panneau du moniteur

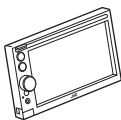

Mounting bolt—M4 x 20 mm/M4 x 13/16"
Perno de montaje—M4 x 20 mm/M4 x 13/16 pulgadas
Boulon de montage—M4 x 20 mm/M4 x 13/16 pouces



Washer (ø5)
Arandela (ø5)
Rondelle (ø5)



Rubber cushion
Cojin de goma
Amortisseur en caoutchouc



Lock nut (M5)
Tuerca de seguridad (M5)
Ecrou d'arrêt (M5)



Flat head screws (M5 x 8 mm/M5 x 3/8")
Round head screws (M5 x 8 mm/M5 x 3/8")
Tornillos de cabeza plana (M5 x 8 mm/M5 x 3/8 pulgadas)
Tornillos de cabeza esférica (M5 x 8 mm/M5 x 3/8 pulgadas)
Vis à tête plate (M5 x 8 mm/M5 x 3/8 pouces)
Vis à tête ronde (M5 x 8 mm/M5 x 3/8 pouces)



Use these screws when installing the unit without the supplied sleeve. (See page 2.)
Utilice estos tornillos cuando instale la unidad sin la cubierta suministrada. (Consulte la página 2.)
Utilisez ces vis lors de l'installation de l'appareil sans le manchon fourni. (Voir page 2.)

Only for KW-ADV65BT/KW-AV61BT
Sólo para KW-ADV65BT/KW-AV61BT
Uniquement pour le KW-ADV65BT/KW-AV61BT

Microphone
Microfono
Microphone



Bluetooth adapter (attached)
Adaptador Bluetooth (insertado)
Adaptateur Bluetooth (inséré) **KS-UBT1**



Bag for storing the adapter
Funda para guardar el adaptador
Sac pour ranger l'adaptateur



INSTALLATION (IN-DASH MOUNTING)

The following illustration shows a typical installation. However, you should make adjustments corresponding to your specific car. If you have any questions or require information regarding installation kits, consult your JVC car audio dealer or a company supplying kits.

- If you are not sure how to install this unit correctly, have it installed by a qualified technician.

Before installing the unit

- Remove the audio system originally installed in the car, together with its mounting brackets. Be sure to keep all the screws and parts removed from your car for future use.
- When mounting the unit, be sure to use the screws provided, as instructed. If other screws are used, parts could become loose or damaged.
- When tightening screws or bolts, be careful not to pinch any connection cord.
- Make sure not to block the fan on the rear to maintain proper ventilation when installing the unit.

When installing the unit without using the mounting sleeve

- Use flat head screws or round head screws, depending on installation location. When you use flat head screws to install the unit, use the screws removed in step 1 below. When you use screws other than those supplied, use 8 mm (3/8")-long screws. If longer screws are used, they could damage the unit.
- Tighten the screws firmly to prevent the unit from falling off.

INSTALACIÓN (MONTAJE EN EL TABLERO DE INSTRUMENTOS)

La siguiente ilustración muestra una instalación típica. Sin embargo usted deberá efectuar los ajustes correspondientes a su automóvil. Si tiene alguna pregunta o necesita información acerca de las herramientas para instalación, consulte con su concesionario de JVC de equipos de audio para automóviles o a una compañía que suministra tales herramientas.

- Si no está seguro de poder instalar la unidad correctamente, déjala en manos de un técnico cualificado.

Antes de instalar la unidad

- Desmonte el sistema de audio instalado originalmente en el coche, junto con los ménsulas de montaje. Asegúrese de guardar todos los tornillos y piezas quitados de su vehículo para poderlos usar en el futuro.
- Al instalar la unidad, asegúrese de usar los tornillos suministrados, de acuerdo con las instrucciones. El uso de otros tornillos podrá provocar flojedad de o daños a las piezas.
- Al apretar los tornillos o los pernos, asegúrese de que ningún cable de conexión quede pillado.
- Al efectuar la instalación, asegúrese de no bloquear el ventilador del panel trasero a fin de mantener una ventilación correcta.

Instalación de la unidad sin utilizar la cubierta de montaje

- Utilice tornillos de cabeza plana o esférica, dependiendo del lugar de instalación. Si decide utilizar tornillos de cabeza plana para instalar la unidad, utilice los extraídos en el paso 1, más abajo. Si decide utilizar tornillos distintos de los suministrados, escoja tornillos de 8 mm (3/8") de largo. El uso de tornillos más largos producirá daños a la unidad.
- Apriete los tornillos firmemente para evitar que la unidad se caiga.

INSTALLATION (MONTAGE DANS LE TABLEAU DE BORD)

L'illustration suivante est un exemple d'installation typique.

Cependant, vous devez faire les ajustements correspondant à votre voiture. Si vous avez des questions ou avez besoin d'information sur des kits d'installation, consultez votre revendeur d'autoradios JVC ou une compagnie d'approvisionnement.

- Si vous n'êtes pas sûr de pouvoir installer l'appareil correctement, faites-le installer par un technicien qualifié.

Avant d'installer l'appareil

- Retirez le système audio d'origine installé dans la voiture en même temps que les supports de montage. Assurez-vous de conserver toutes les vis et pièces détachées de votre voiture pour une utilisation dans le future.
- Lors du montage de l'appareil, assurez-vous d'utiliser les vis fournies, de la façon indiquée. Si vous utilisez d'autres vis, certaines pièces peuvent être perdues ou endommagées.
- Lorsque vous serrez des vis ou des boulons, faites attention de ne pas pincer un cordon de connexion.
- Assurez-vous de ne pas bloquer le ventilateur sur le panneau arrière lors de l'installation afin de permettre une ventilation correcte.

Lors de l'installation de l'appareil sans utiliser de manchon de montage

- Utilisez des vis à tête plate ou des vis à tête ronde, en fonction de l'emplacement de l'installation. Quand vous utilisez des vis à tête plate pour installer l'appareil, utilisez les vis retirées à l'étape 1 ci-dessous. Quand vous utilisez d'autres vis que les vis fournies, utilisez des vis d'une longueur de 8 mm (3/8"). Vous risquez d'endommager l'appareil si vous utilisez des vis plus longues.
- Serrez les vis solidement pour éviter que l'appareil tombe.

- 1 Detach the trim plate and remove the screws.
- 2 Detach the mounting sleeve using the extraction keys then slide off the mounting sleeve.
- 3 Install the mounting sleeve in the dashboard of the car.
- 4 Do the required electrical connections.
 - See pages 3 - 6.
- 5 Attach the trim plate to the main unit, then install the main unit in to the mounting sleeve.
- 6 Attach the monitor panel.

- 1 Desmonte la placa de guarnición y extraiga los tornillos.
- 2 Con las llaves de extracción, desmonte la cubierta de montaje deslizándola.
- 3 Instale la cubierta de montaje en el tablero de instrumentos del vehículo.
- 4 Realice todas las conexiones eléctricas necesarias.
 - Consulte las páginas 3 - 6.
- 5 Fije la placa de guarnición a la unidad principal y luego inserte la unidad principal dentro de la cubierta de montaje.
- 6 Fije el panel del monitor.

- 1 Détachez la plaque d'assemblage et retirez les vis.
- 2 Détachez le manchon de montage en utilisant les clés d'extraction puis faites le glisser vers l'extérieur pour le retirer.
- 3 Installez le manchon de montage dans le tableau de bord de la voiture.
- 4 Réalisez les connexions électriques.
 - Voir pages 3 - 6.
- 5 Attachez la plaque de garniture sur l'appareil principale, puis installez l'appareil dans le manchon de montage.
- 6 Attachez le panneau du moniteur.

1

Mounting sleeve
Cubierta de montaje
Manchon de montage

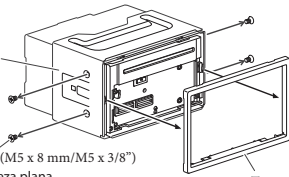

Flat head screws (M5 x 8 mm/M5 x 3/8")
Tornillos de cabeza plana
(M5 x 8 mm/M5 x 3/8 pulgada)
Vis à tête plate (M5 x 8 mm/M5 x 3/8 pouces)

Trim plate
Placa de guarnición
Plaque d'assemblage

2

Extraction key
Llaves de extracción
Clés d'extraction

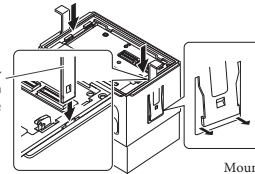

Mounting sleeve
Cubierta de montaje
Manchon de montage

When you stand the unit, be careful not to damage the fuse on the rear.

Al poner la unidad vertical, tenga cuidado de no dañar el fusible provisto en la parte posterior.

Lorsque vous mettez l'appareil à la verticale, faire attention de ne pas endommager le fusible situé sur l'arrière.

3

Mounting sleeve
Cubierta de montaje
Manchon de montage

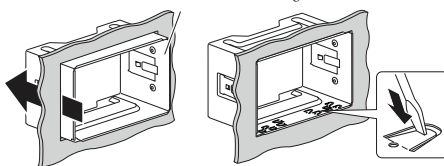

Bend the appropriate tabs to hold the mounting sleeve firmly in place.
Doble las lengüetas apropiadas para retener firmemente la cubierta de montaje en su lugar.

Tordez les languettes appropriées pour maintenir le manchon de montage en place.

4

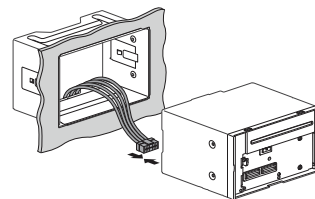

For more stable attachment
Para una fijación más estable
Pour que la fixation soit plus stable

- (A) Stay (option) / Soporte (opción) / Hauban (en option)
- (B) Screw (option) / Tornillo (opción) / Vis (en option)
- (C) Lock nut / Tuerca de seguridad / Ecrou d'arrêt
- (D) Washer / Arandela / Rondelle
- (E) Mounting bolt / Perno de montaje / Boulon de montage

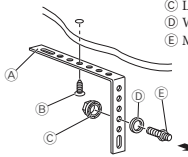

To the rear panel
Al panel trasero
Sur le panneau arrière

5

Mounting sleeve
Cubierta de montaje
Manchon de montage

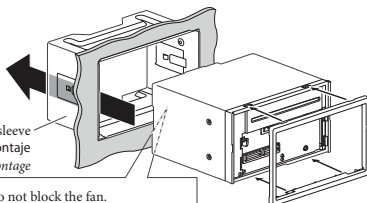

Do not block the fan.
No tape las rejillas de ventilación.
Ne bloquez pas le ventilateur.

Trim plate
Placa de guarnición
Plaque d'assemblage

Slide the unit in until you hear a clicking sound.
Deslice la unidad hasta escuchar un chasquido.
Faites glisser l'appareil jusqu'à ce que vous entendiez un clic.

6

Monitor panel
Panel del monitor
Panneau du moniteur

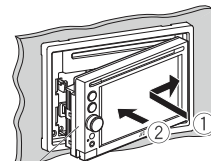

DO NOT press the panel (shaded in the illustration).
NO presione el panel (sombreado en la ilustración).
NE Poussez PAS sur le panneau (en gris sur l'illustration).

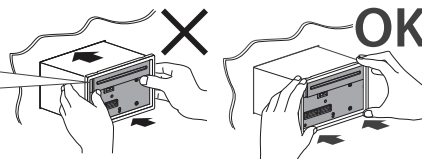

Install the unit at an angle of less than 30°.
Instale la unidad a un ángulo de menos de 30°.
Installez l'appareil avec un angle de moins de 30°.

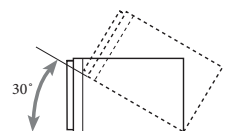

Removing the unit

Before removing the unit, release the rear section.

Extracción de la unidad

Antes de extraer la unidad, libere la sección trasera.

Retrait de l'appareil

Avant de retirer l'appareil, libérez la section arrière.

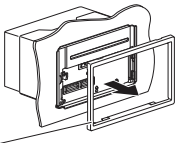
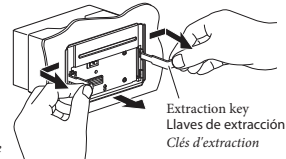
<p>1 Detach the monitor panel (see page 5 of the INSTRUCTION MANUAL). Desmonte el panel del monitor (consulte la página 5 del MANUAL DE INSTRUCCIONES). Débranchez le panneau du moniteur (voir la page 5 du MODE D'EMPLOI).</p>	<p>2 Detach the trim plate. Desmonte la placa de guarnición. Débranchez la plaque d'assemblage.</p> <p>Trim plate Placa de guarnición Plaque d'assemblage</p> 	<p>3 Insert the two extraction keys, then pull them as illustrated so that the unit can be removed. Inserte las dos llaves de extracción y, a continuación, extrájalas de la manera indicada en la ilustración para que la unidad pueda desmontarse. Insérez les deux clés d'extraction, puis tirez de la façon illustrée de façon à retirer l'appareil.</p>  <p>Extraction key Llaves de extracción Clés d'extraction</p>
---	--	--

ELECTRICAL CONNECTIONS

CONEXIONES ELECTRICAS

RACCORDEMENTS ELECTRIQUES

PRECAUTIONS on power supply and speaker connections:

- DO NOT connect the speaker leads of the wiring harness to the car battery; otherwise, the unit will be seriously damaged.
- BEFORE connecting the speaker leads of the wiring harness to the speakers, check the speaker wiring in your car.

PRECAUCIONES sobre las conexiones de la fuente de alimentación y de los altavoces:

- NO conecte los cables de los altavoces del mazo de cables a la batería del coche, de lo contrario, la unidad quedará seriamente dañada.
- ANTES de conectar los cables de los altavoces del mazo de cables a los altavoces, revise el cableado de los altavoces de su coche.

PRECAUTIONS sur l'alimentation et la connexion des enceintes:

- NE CONNECTEZ PAS les fils d'enceintes du câblage électrique à la batterie; sinon, l'appareil serait sérieusement endommagé.
- AVANT de connecter les fils d'enceintes du câblage électrique aux enceintes, vérifiez le câblage des enceintes de votre voiture.

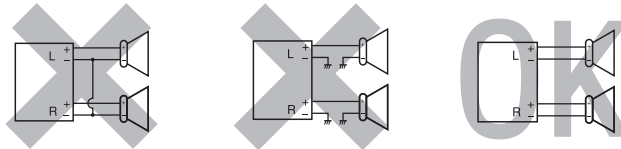

Connecting the parking brake lead / Conexión del cable del freno de estacionamiento / Connexion du fil de frein de stationnement

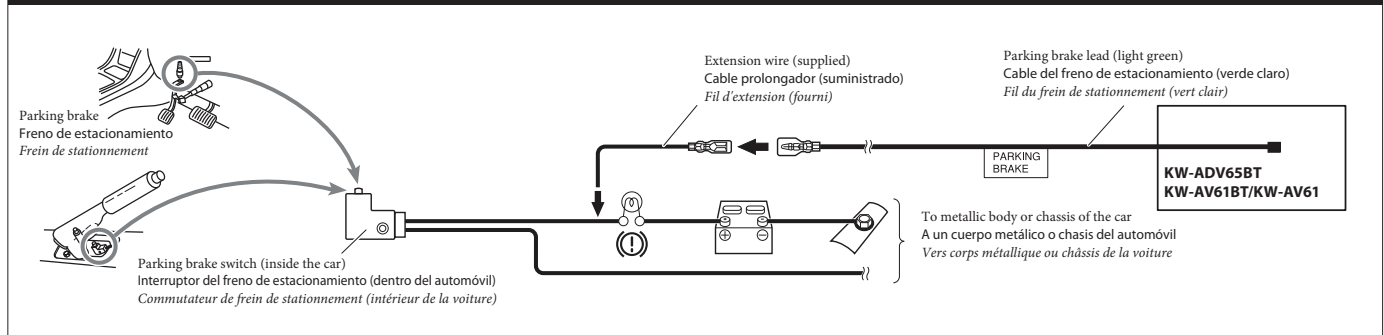

Connecting the reverse gear signal lead (for rear view camera) / Conexión del cable de señal del engranaje de marcha atrás (para cámara de retrovisión) / Connexion du fil de signal de marche arrière (pour la caméra de recul)

Locate the reverse lamp lead in the trunk.

Localice el conductor de la luz de marcha atrás en el portaequipajes.

Localisez le fil des feux de recul dans le coffre.

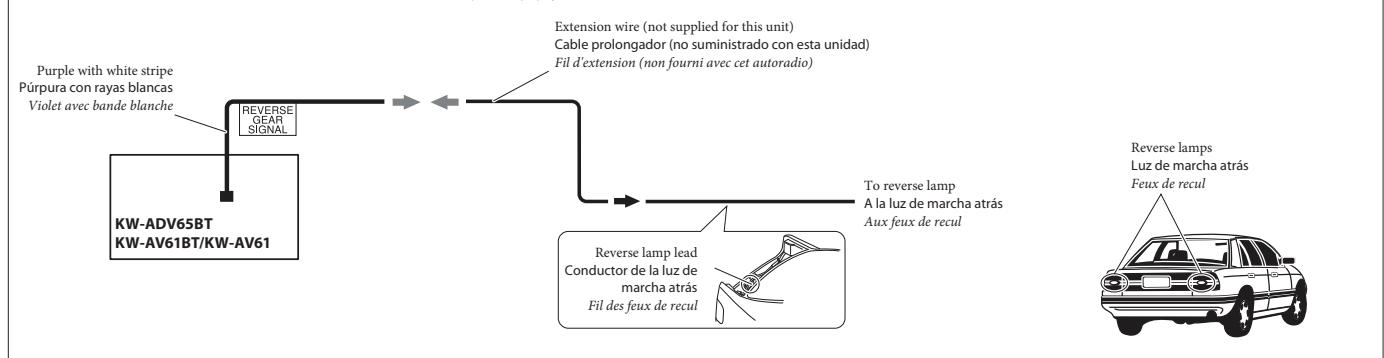

Before connecting: Check the wiring in the vehicle carefully. Incorrect connection may cause serious damage to this unit. The leads of the wiring harness and those of the connector from the car body may be different in color.

- 1 Connect the colored leads of the wiring harness in the order specified in the illustration below.
- 2 Connect the antenna cord.
- 3 Finally connect the wiring harness to the unit.

Antes de la conexión: Verifique atentamente el conexionado del vehículo. Una conexión incorrecta podría producir daños graves en la unidad. Los colores de los cables del mazo de cables y los del conector de la carrocería del coche pueden ser diferentes.

- 1 Conecte los cables de colores del mazo de cables en el orden especificado en la siguiente ilustración.
- 2 Conecte el cable de antena.
- 3 Por último, conecte el cable de alimentación a la unidad.

Avant de commencer la connexion: Vérifiez attentivement le câblage du véhicule. Une connexion incorrecte peut endommager sérieusement l'appareil. Les fils du câblage électrique et ceux des connecteurs du châssis de la voiture peuvent être différents en couleur.

- 1 Connectez les fils colorés du câblage électrique dans l'ordre spécifié sur l'illustration ci-dessous.
- 2 Connectez le cordon d'antenne.
- 3 Finalement, connectez le faisceau de fils à l'appareil.

The terminals and cables of all models are shown in the illustration for the purpose of explanation.

Los terminales y cables de todos los modelos se muestran en la ilustración con fines explicativos.

Les prises et les câbles de tous les modèles sont montrés sur les illustrations dans un but explicatif.

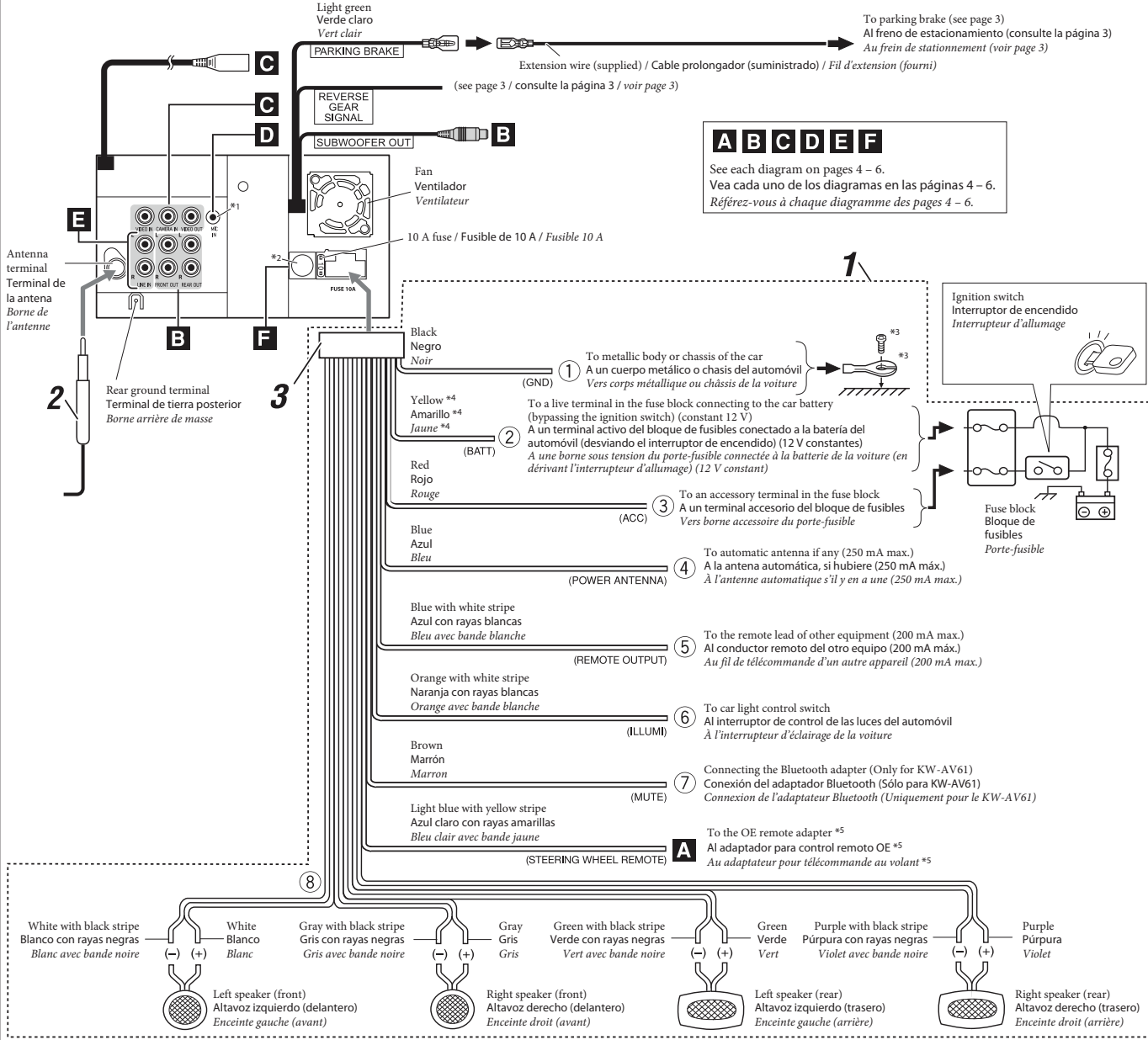

A B C D E F
 See each diagram on pages 4 – 6. / Veá cada uno de los diagramas en las páginas 4 – 6. / Référez-vous à chaque diagramme des pages 4 – 6.

A Connecting to the steering wheel remote controller / Conexión al control remoto del volante de dirección / Connexion de la télécommande de volant

If your car is equipped with the steering wheel remote controller, you can operate this unit using the controller. For connection, an exclusive remote adapter (not supplied) which matches your car is required. For details, consult the same car audio dealer as where the unit is purchased.

Si su vehículo está equipado con control remoto en el volante de dirección, podrá hacer funcionar este receptor utilizando dicho control. Para la conexión, se requiere un adaptador remoto exclusivo (no suministrado) que sea adecuado para su automóvil. Para los detalles, consulte con el concesionario car audio donde compró el receptor.

Si votre voiture est munie d'une télécommande de volant, vous pouvez commander cet autoradio en utilisant la télécommande. Pour la connexion, un adaptateur de télécommande exclusif (non fourni) correspondant à votre voiture est requis. Pour en savoir plus, consultez le revendeur autoradio auprès duquel vous avez acheté cet autoradio.

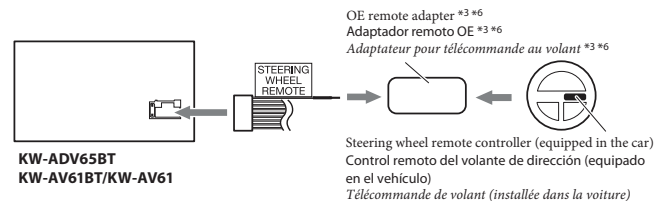

*1 Only for KW-ADV65BT/KW-AV61BT.
 *2 Only for KW-ADV65BT Region 1/KW-AV61BT Region 1/KW-AV61 Region 1.
 *3 Not supplied for this unit.
 *4 Before checking the operation of this unit prior to installation, this lead must be connected, otherwise power cannot be turned on. Do not connect the lead directly to the battery.
 *5 Do not connect the lead to any device other than the OE remote adapter. Doing so may cause malfunction.
 *6 Alter the wire of the OE remote adapter to connect to the steering wheel remote lead.

*1 Sólo para KW-ADV65BT/KW-AV61BT.
 *2 Solo para KW-ADV65BT Región 1/KW-AV61BT Región 1/KW-AV61 Región 1.
 *3 No suministrado con esta unidad.
 *4 Antes de comprobar el funcionamiento de esta unidad previa a de la instalación, es necesario conectar este cable, de lo contrario no se podrá conectar la alimentación. No conecte el conductor directamente a la batería.
 *5 No conecte el cable a ningún otro dispositivo que no sea el adaptador para control remoto OE. De lo contrario podría provocar un mal funcionamiento.
 *6 Altere el cableado del adaptador para control remoto OE para conectar al conductor remoto del volante de dirección.

*1 Uniquement pour le KW-ADV65BT/KW-AV61BT.
 *2 Uniquement pour le KW-ADV65BT Région 1/KW-AV61BT Région 1/KW-AV61 Région 1.
 *3 Non fourni avec cet appareil.
 *4 Pour vérifier le fonctionnement de cet appareil avant installation, ce fil doit être raccordé, sinon l'appareil ne peut pas être mis sous tension. Ne connectez pas le fil directement à la batterie.
 *5 Ne connectez pas ce fil à aucun autre appareil que l'adaptateur de télécommande au volant. Cela pourrait causer un mauvais fonctionnement.
 *6 Modifiez le fil de l'adaptateur de télécommande au volant pour le connecter au fil de télécommande de volant.

B Connecting the external amplifiers and subwoofer / Conexión de los amplificadores y subwoofer / Connexion d'amplificateurs extérieurs et d'un caisson de grave

- You can connect an amplifier to upgrade your car stereo system.
- Connect the remote lead (blue with white stripe) to the remote lead of the other equipment so that it can be controlled through this unit.
 - Disconnect the speakers from this unit, and connect them to the amplifier. Leave the speaker leads of this unit unused.**
 - You can switch off the built-in amplifier and send the audio signals only to the external amplifier(s) to get clear sounds and to prevent internal heat built-up inside the unit. See page 46 of the INSTRUCTION MANUAL.

- Puede conectar amplificadores para mejorar su sistema car estéreo.
- Conecte el conductor remoto (azul con rayas blancas) al conductor remoto del otro equipo para poderlo controlar a través de esta unidad.
 - Desconecte los altavoces de esta unidad y conéctelos al amplificador. Los cables de los altavoces de esta unidad quedan sin usar.**
 - Podrá desconectar el amplificador incorporado y enviar las señales de audio solamente al(los) amplificador(es) externo(s) para obtener sonidos nítidos y evitar que se caliente el interior de la unidad. Consulte la página 46 del MANUAL DE INSTRUCCIONES.

- Vous pouvez connecter un amplificateur pour améliorer votre système autoradio.
- Connectez le fil de commande à distance (bleu avec bande blanche) au fil de commande à distance de l'autre appareil de façon qu'il puisse être commandé via cet appareil.
 - Déconnectez les enceintes de cet appareil et connectez-les à l'amplificateur. Laissez les fils d'enceintes de cet appareil inutilisés.**
 - Vous pouvez mettre hors service l'amplificateur intégré et envoyer les signaux audio uniquement sur un ou plusieurs amplificateurs extérieurs afin d'obtenir un son clair et d'éviter tout échauffement interne de l'autoradio. Voir page 46 du MODE D'EMPLOI.

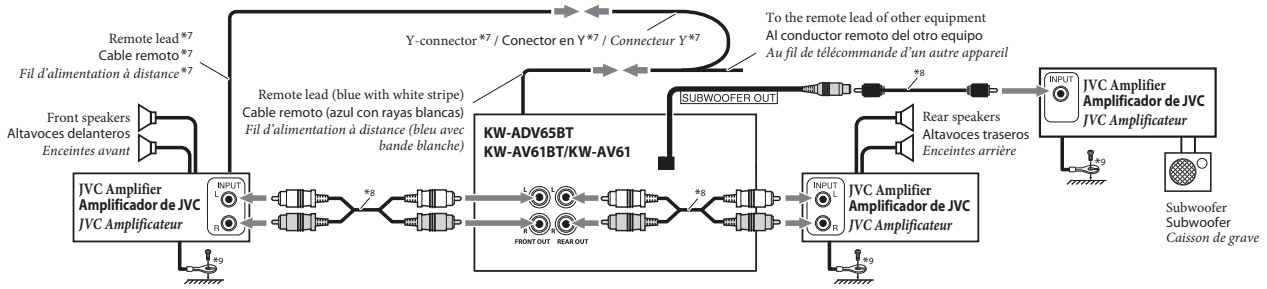

C Connecting the external components / Conectando los componentes externos / Connexion des appareils extérieurs

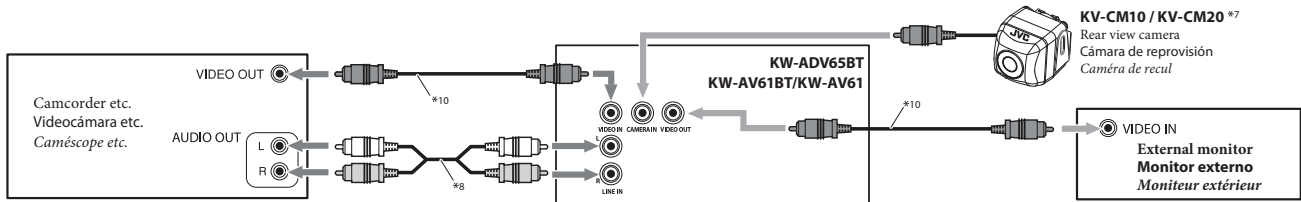

Connecting the iPod or the iPhone / Conexión del iPod o iPhone / Connexion d'un iPod ou d'un iPhone

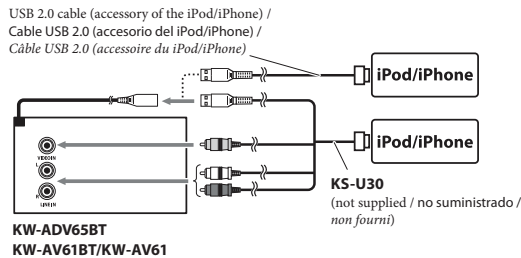

- To watch video**, connect the iPod/iPhone using JVC KS-U30 ^{*11} (separately purchased), otherwise, video is not displayed on the screen.
- To listen to music**, connect the iPod/iPhone using a USB 2.0 cable (accessory of the iPod/iPhone).
- Para ver video**, conecte el iPod/iPhone mediante el JVC KS-U30 ^{*11} (en venta por separado); de lo contrario, no aparecerá video en la pantalla.
- Para escuchar música**, conecte el iPod/iPhone mediante un cable USB 2.0 (accesorio del iPod/iPhone).
- Pour voir une séquence vidéo**, connectez l'iPod/iPhone en utilisant le JVC KS-U30 ^{*11} (vendu séparément), sinon, l'image vidéo n'apparaît pas sur l'écran.
- Pour écouter la musique**, connectez l'iPod/iPhone en utilisant le câble USB 2.0 (accessoire du iPod/iPhone).

USB devices / Dispositivos USB / Périphériques USB

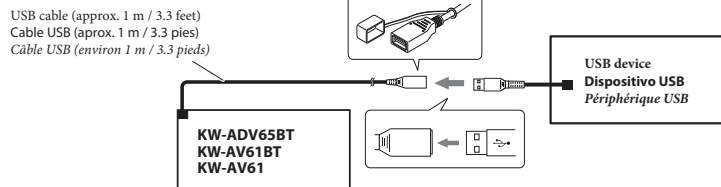

^{*7} Not supplied for this unit.

^{*8} Audio cord (not supplied for this unit).

^{*9} Firmly attach the ground wire to the metallic body or to the chassis of the car—to the place uncoated with paint (if coated with paint, remove the paint before attaching the wire). Failure to do so may cause damage to the unit.

^{*10} Video cord (not supplied for this unit).

^{*11} When using the cable, you need to change the setting on the unit (see page 26 of the INSTRUCTION MANUAL).

^{*7} No suministrado con esta unidad.

^{*8} Cable de audio (no suministrado con esta unidad).

^{*9} Fije firmemente el cable de tierra a la carrocería metálica o al chasis—a un lugar no cubierto con pintura (si está cubierto con pintura, quítela antes de fijar el cable). De lo contrario, se podrían producir daños en la unidad.

^{*10} Córdón de video (no suministrado con esta unidad).

^{*11} Cuando utilice el cable, deberá cambiar el ajuste en la unidad (consulte la página 26 del MANUAL DE INSTRUCCIONES).

^{*7} Non fourni avec cet appareil.

^{*8} Cordon audio (non fourni avec cet appareil).

^{*9} Attachez solidement le fil de mise à la masse au châssis métallique de la voiture—à un endroit qui n'est pas recouvert de peinture (s'il est recouvert de peinture, enlevez d'abord la peinture avant d'attacher le fil). L'appareil peut être endommagé si cela n'est pas fait correctement.

^{*10} Cordon vidéo (non fourni avec cet appareil).

^{*11} Lors de l'utilisation du câble, vous devez changer le réglage sur l'appareil (voir page 26 du MODE D'EMPLOI).

D Connecting the microphone (Only for KW-ADV65BT/KW-AV61BT) / Conexión de la unidad de micrófono (Sólo para KW-ADV65BT/KW-AV61BT) / Connexion du microphone (Uniquement pour le KW-ADV65BT/KW-AV61BT)

1

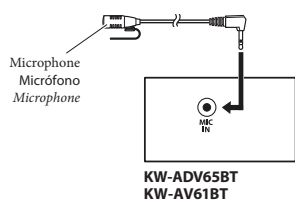

2

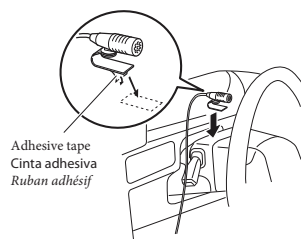

3

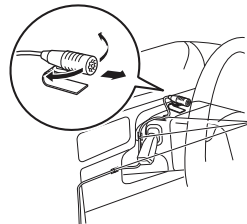

Secure the microphone cord using cord clamps (not supplied) if necessary.
Si es necesario, asegure el cable del micrófono por medio de abrazaderas (no suministradas).
Fixez si nécessaire le cordon du microphone en utilisant des serre-fils (non fournis).

E Connecting the Bluetooth adapter (Only for KW-AV61) / Conexión del adaptador Bluetooth (Sólo para KW-AV61) / Connexion de l'adaptateur Bluetooth (Uniquement pour le KW-AV61)

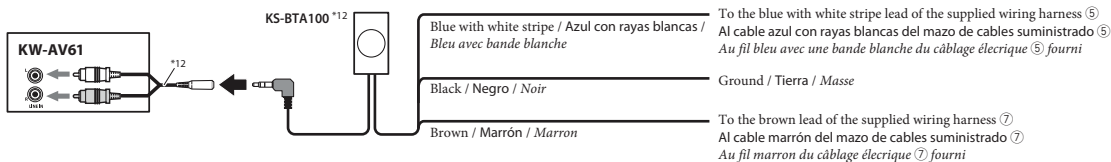

See page 61 of the INSTRUCTION MANUAL. / Consulte la página 61 del MANUAL DE INSTRUCCIONES. / Voir page 61 du MODE D'EMPLOI.

F Connecting the SiriusXM tuner (Only for KW-ADV65BT Region 1/KW-AV61BT Region1/KW-AV61 Region 1) / Conexión del sintonizador SiriusXM (Solo para KW-ADV65BT Región 1/KW-AV61BT Región1/KW-AV61 Región 1) / Connexion du tuner SiriusXM (Uniquement pour le KW-ADV65BT Région 1/KW-AV61BT Région1/ KW-AV61 Région 1.)

When connecting the SiriusXM tuner, refer also to the manual supplied for it.

Cuando conecte el sintonizador SiriusXM, consulte también el manual suministrado con el mismo.

Lors de la connexion du tuner SiriusXM tuner, reportez-vous aussi au mode d'emploi qui l'accompagne.

CAUTION: Before connecting the SiriusXM tuner, make sure that the unit is turned off.

PRECAUCIÓN: Antes de conectar el sintonizador SiriusXM, asegúrese de que la unidad esté apagada.

PRECAUTION: Avant de connecter le tuner SiriusXM, assurez-vous que l'appareil est hors tension.

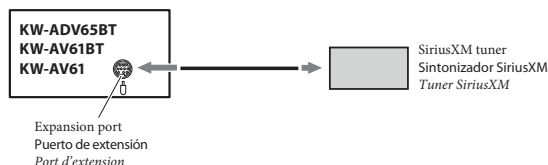

To disconnect the connector
Para desconectar el conector
Pour déconnecter le connecteur

Grip the connector top tightly (1).
Sostenga el conector con firmeza (1).
Tenez fermement le haut de l'adaptateur (1).

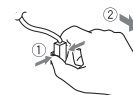

Pull out (2).
Extráigalo (2).
Tirez (2).

*12 Not supplied for this unit.

*12 No suministrado con esta unidad.

*12 Non fourni avec cet appareil.

TROUBLESHOOTING

- **The fuse blows.**
 - * Are the red and black leads connected correctly?
- **Power cannot be turned on.**
 - * Is the yellow lead connected?
- **No sound from the speakers.**
 - * Is the speaker output lead short-circuited?
- **Sound is distorted.**
 - * Is the speaker output lead grounded?
 - * Are the "-" terminals of L and R speakers grounded in common?
- **Noise interferes with sounds.**
 - * Is the rear ground terminal connected to the car's chassis using shorter and thicker cords?
- **This unit becomes hot.**
 - * Is the speaker output lead grounded?
 - * Are the "-" terminals of L and R speakers grounded in common?
- **This unit does not work at all.**
 - * Have you reset your unit?

LOCALIZACIÓN DE AVERIAS

- **El fusible se quema.**
 - * ¿Están los conductores rojo y negro correctamente conectados?
- **No es posible conectar la alimentación.**
 - * ¿Está el cable amarillo conectado?
- **No sale sonido de los altavoces.**
 - * ¿Está el cable de salida del altavoz cortocircuitado?
- **El sonido presenta distorsión.**
 - * ¿Está el cable de salida del altavoz conectado a masa?
 - * ¿Están los terminales "-" de los altavoces L y R conectados a una masa común?
- **Perturbación de ruido.**
 - * ¿El terminal de tierra trasero está conectado al chasis del automóvil utilizando los cordones más corto y más grueso?
- **La unidad se calienta.**
 - * ¿Está el cable de salida del altavoz conectado a masa?
 - * ¿Están los terminales "-" de los altavoces L y R conectados a una masa común?
- **Este receptor no funciona en absoluto.**
 - * ¿Reinicializó el receptor?

EN CAS DE DIFFICULTES

- **Le fusible saute.**
 - * Les fils rouge et noir sont-ils raccordés correctement?
- **L'appareil ne peut pas être mise sous tension.**
 - * Le fil jaune est-elle raccordée?
- **Pas de son des enceintes.**
 - * Le fil de sortie d'enceinte est-il court-circuité?
- **Le son est déformé.**
 - * Le fil de sortie d'enceinte est-il à la masse?
 - * Les bornes "-" des enceintes gauche et droit sont-elles mises ensemble à la masse?
- **Interférence avec les sons.**
 - * La prise arrière de mise à la terre est-elle connectée au châssis de la voiture avec un cordon court et épais?
- **L'appareil devient chaud.**
 - * Le fil de sortie d'enceinte est-il à la masse?
 - * Les bornes "-" des enceintes gauche et droit sont-elles mises ensemble à la masse?
- **Cet appareil ne fonctionne pas du tout.**
 - * Avez-vous réinitialisé votre appareil?

KW-AV61BT/KW-AV61/KW-ADV65BT

iPhone/iPod users:

PLEASE READ THIS BEFORE USING YOUR NEW UNIT

You have two options when connecting an iPhone or an iPod to your new unit:

■ Option 1 (Default Setting): Using the optional JVC KS-U30

Your unit is pre-set from the factory to allow **audio and video** playback when you connect your iPhone or iPod using the optional JVC KS-U30 cable (Sold Separately). If you purchased the KS-U30, simply connect your iPhone or iPod using this optional cable.



■ Option 2 :

If you wish to connect your iPhone or iPod with white 30-Pin iPod USB Cable (this is the white cable that is supplied with your iPhone or iPod), you will need to follow the simple steps below to assure **audio** playback:

Please go to [HOME] >> Select [AV Off] >> Select [HOME] >> Select [Settings] >> [Input], then select [AV-IN] at "AV Input" Menu.

Important Notice:

When you using your white 30-Pin iPod USB Cable, audio signal does not come through via USB if you select "iPod". You must select "AV-IN" when using your white 30-Pin iPod USB Cable.

Setting <AV Input> for iPod/iPhone playback

Configuración de <AV Input> para la reproducción de iPod/iPhone

Réglage <AV Input> pour la lecture du iPod/iPhone

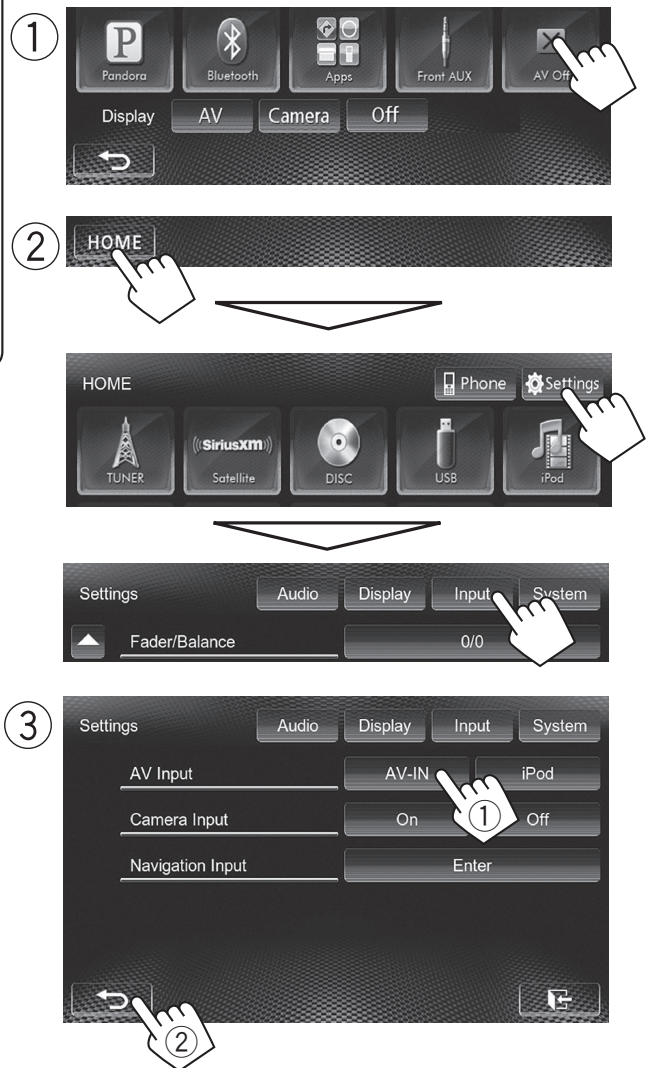

Usuarios de iPhone o iPod:

Por favor lea esto antes de usar su nueva unidad

Utilisateurs d'iPhone et d'iPod:

Veillez lire ceci avant d'employer votre nouvelle unité

Usted tiene dos opciones cuando usted que conecta un iPhone o un iPod con su nueva unidad:

■ **Opción 1 (Ajuste Predeterminado): Usando el accesorio opcional JVC modelo KS-U30**

Su unidad viene pre-ajustada de fábrica para permitir la reproducción de **audio y video** cuando Ud. Conecte su iPhone o iPod utilizando el cable opcional JVC modelo KS-U30 (vendido por separado). Si usted compró el ks-u30, conecte simplemente su iPhone o iPod usando este cable opcional.



■ **Opción 2 :**

Si usted desea conectar su iPhone o iPod con el cable USB de 30-Pines iPod (éste es el cable blanco que se suministra su iPhone o iPod), usted necesitará seguir los siguientes pasos para la reproducción de **audio** :

**Presione [HOME] >>
Seleccione [AV Off] >>
Seleccione [HOME] >>
Seleccione [Settings] >>[Input], Entonces, seleccione [AV-IN] en el Menú "AV Input".**

Aviso importante:

Si al usar el cable USB de iPod de 30 pines blanco, la señal de audio no llega vía USB al seleccionar iPod. Usted deberá seleccionar "AV-IN" al usar su cable USB de iPod de 30 pines.

Vous avez deux options quand vous reliant un iPhone ou un iPod a votre nouvelle unite:

■ **Option 1 (Arrangement de default): Utilisant le JVC KS-U30 en option**

Votre unité est pré-réglée de l'usine pour permettre la lecture **audio et vidéo** quand vous reliez votre iPhone ou iPod en utilisant le câble JVC KS-U30 en option (vendu séparément). Si vous avez achetez le KS-U30, reliez simplement votre iPhone ou iPod en utilisant ce câble en option.



■ **Option 2 :**

Si vous voulez relier votre iPhone ou iPod au câble blanc d'USB de 30-Pin iPod (c'est le câble blanc qui est fourni avec votre iPhone ou iPod), vous devrez suivre l'étape ci-dessous pour assurer la lecture **audio**:

**Veillez aller à [HOME] >>
Choisissez [AV Off] >>
Choisissez [HOME] >>
Choisissez [Settings] >>[Input], Puis, sélectionner [AV-IN] au Menu "AV Input".**

Notification importante:

En utilisant le câble USB pour iPod à 30-Pin blanc, le signal audio n'apparaît pas par USB si vous choisissez "iPod". Vous devez choisir "AV-IN" quand vous utilisez votre câble USB pour iPod blanc à 30-Pin.

When it is not required to detach the front control panel from the main unit, use the provided screws to attach the control panel to the main unit.

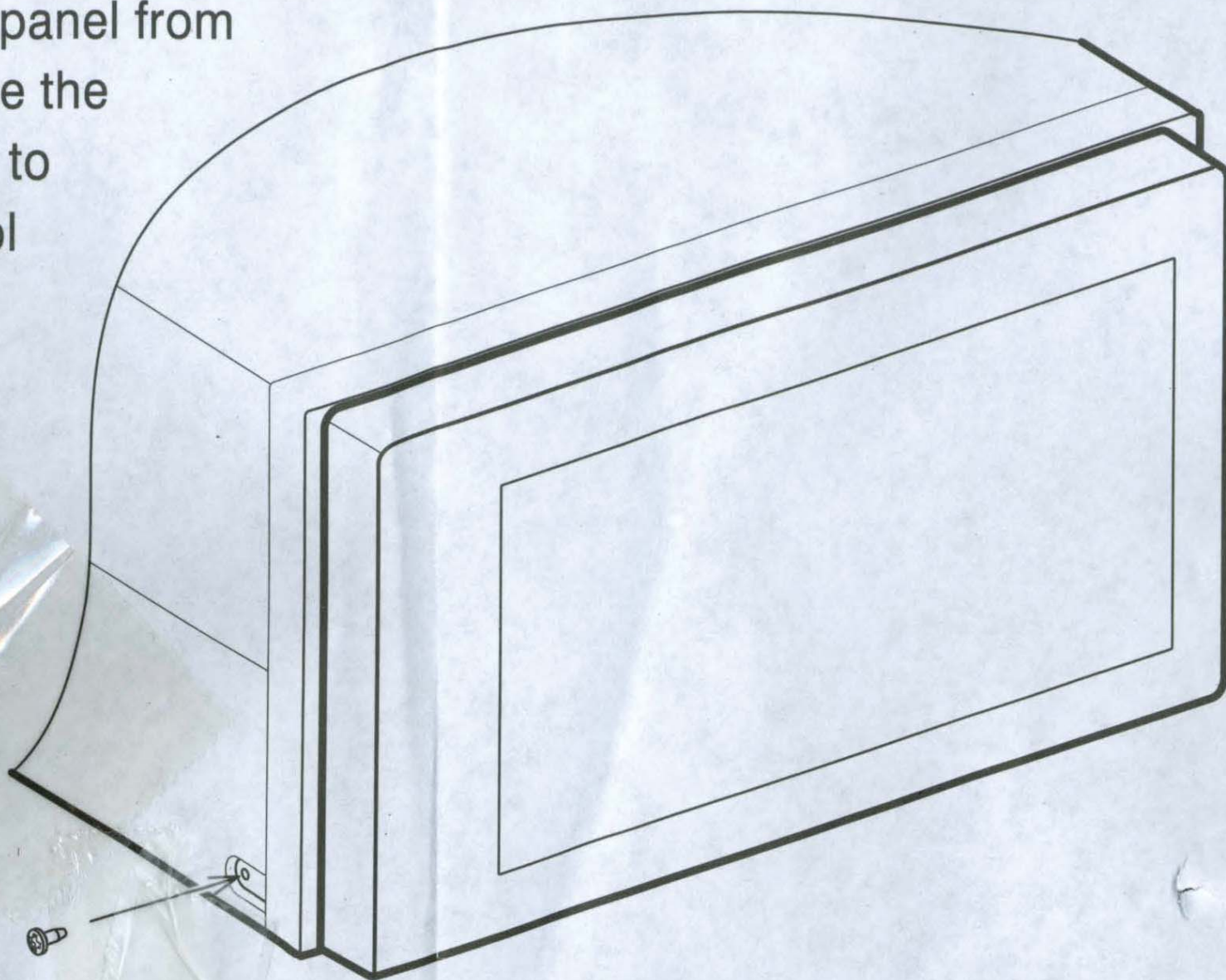

LV45426-001A

Caution on cleaning the unit

Do not use any solvent (for example, thinner, benzine, etc.), detergent, or insecticide. This may damage the monitor or the unit.

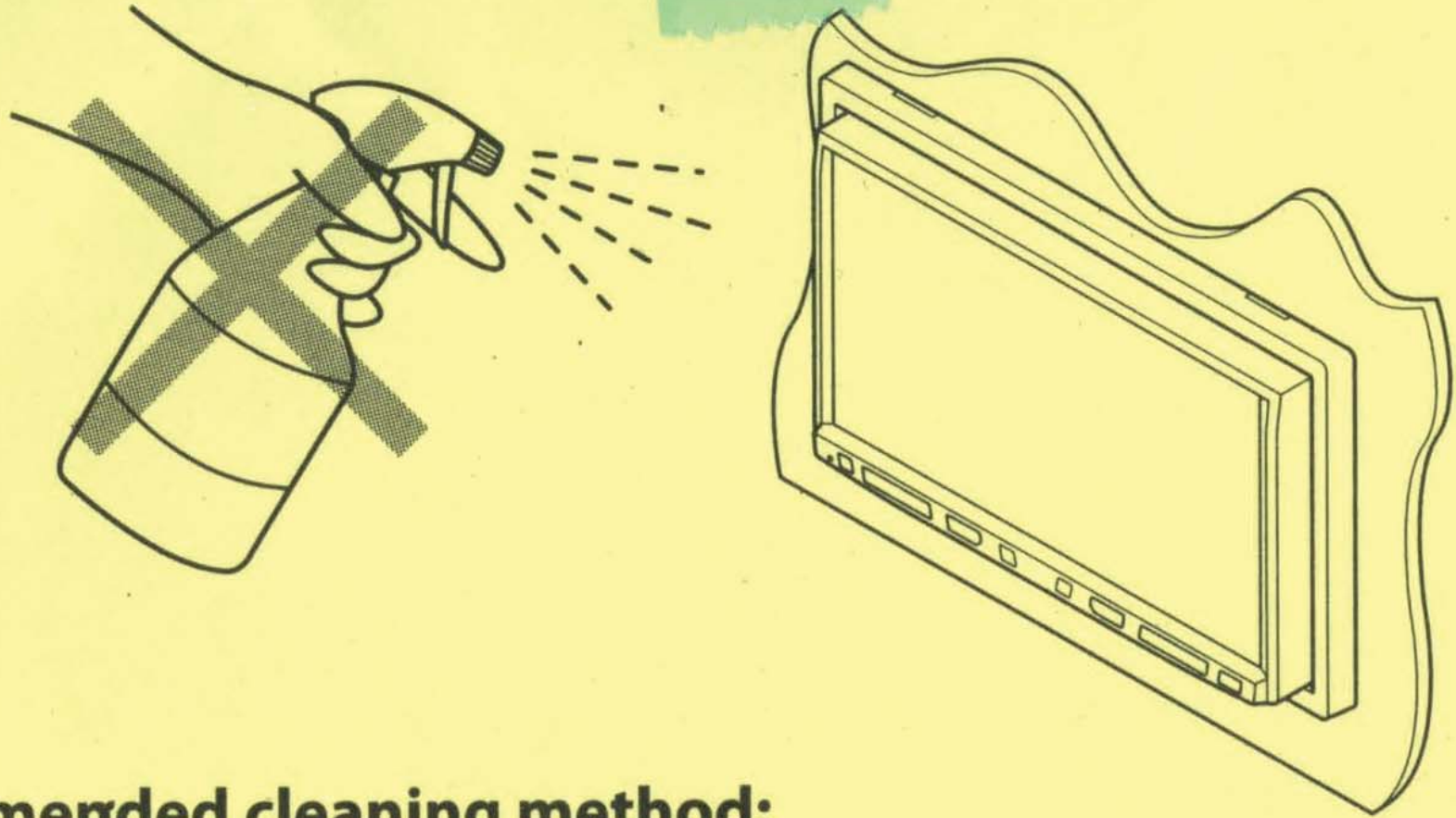

Recommended cleaning method:

Gently wipe the panel with a soft, dry cloth.

LVT1970-001A

REMOVE THIS LABEL FROM CABLE BEFORE USE.

RETIRE LA ÉTIQUETA DEL CABLE ELÉCTRICO ANTES DE USAR.

RETIREZ CETTE ÉTIQUETTE DU CÂBLE AVANT UTILISATION.



CAUTION

CONNECT BLACK WIRE (① GND) TO GROUND FIRST. OTHERWISE, DAMAGE TO YOUR UNIT MAY OCCUR.

INCORRECT CONNECTION CAUSES SERIOUS DAMAGE TO THIS UNIT
PLEASE READ INSTALLATION/CONNECTION MANUAL CAREFULLY.

①

CONNECT GROUND FIRST

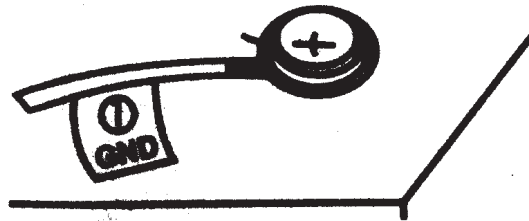

METALLIC BODY OR CHASSIS
OF THE CAR

②

CONNECT OTHER WIRES

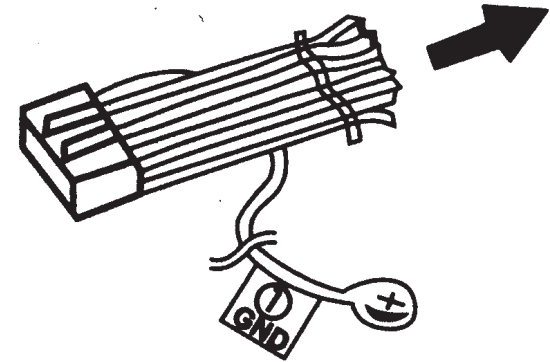

③

CONNECT ANTENNA TERMINAL

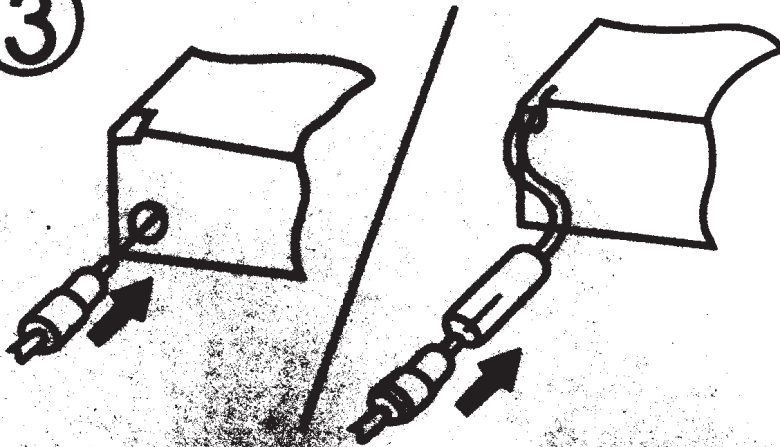

④

CONNECT POWER CORD TO
THE UNIT

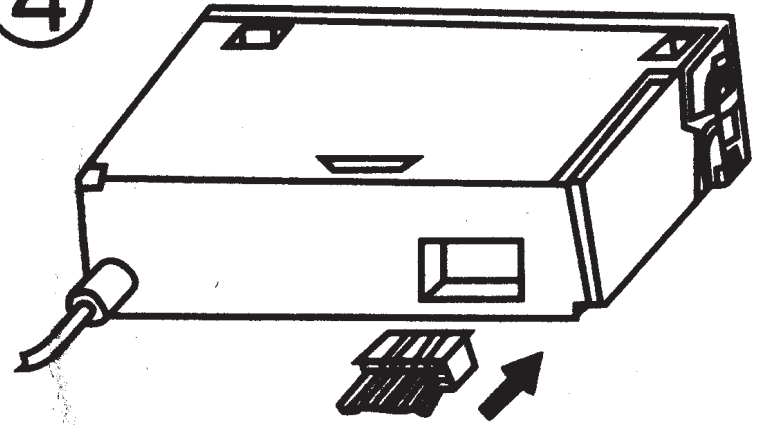

CANADA
ONLY

JVC

CANADA
SEULEMENT

**OWNER'S COPY OF WARRANTY CARD
COPIE D'ENREGISTREMENT DE LA GARANTIE
DU PROPRIÉTAIRE**

(Save sales docket together with this warranty card, as a proof of date of purchase.
La facture et cette garantie sont vos preuves de la date d'achat; rangez-les.)

MODEL SERIAL NO.
MODÈLE NO DE SÉRIE

Purchase from Date purchased
Acheté chez Date acheté

Dealer's Address
Adresse du Vendeur

No. Street
No Rue

City or Town Postal Code
Ville Prov. Code Postal

Owner's Name
Nom du Propriétaire

Owner's Address
Adresse du Propriétaire

No. Street Apt.
No Rue App.

City or Town Postal Code
Ville Prov. Code Postal

BT-52009-1
(0912)

Printed in Indonesia

Product Registration/Enregistrement du produit

We suggest that you register your product since it will enable us to contact you directly if it is ever necessary to correct a safety related condition in your product.

You can register at <http://www.jvc.ca/www/Support/Warranty.aspx>

Nous vous conseillons d'enregistrer votre produit, car il nous permettra de vous contacter directement

si jamais elle est nécessaire pour corriger un problème lié à la sécurité de votre produit.

Vous pouvez vous inscrire à <http://www.jvc.ca/www/Support/Warranty.aspx>

Warranty applies only to PRODUCT distributed in Canada by JVC Canada Inc.

JVC

La garantie s'applique seulement aux PRODUITS distribués au Canada par JVC Canada Inc.

WARRANTY GARANTIE

JVC CANADA INC.

6070 kestrel Road, Missisauga, Ontario, L5T 1S8 Canada
TEL: (905) 670-3381 FAX: (905)670-7244

<http://www.jvc.ca>

JVC CANADA INC. (hereafter called "JVC") gives the following express warranty for each new JVC product distributed in Canada by JVC and sold by an authorized JVC dealer.

JVC warrants that this JVC product is free, under normal use and maintenance, from any defects in material and workmanship subject to the following terms and conditions:

1. To Obtain Warranty Service:

- JVC Product requiring service must be Presented together with Proof of purchase.
- The JVC product must be brought in for service to an authorized JVC Service Centre.

2. Limitation:

This Warranty shall not apply to:

- Repair or replacement of any cabinets, batteries, plates, connection cords, antennas, dust covers, knobs, speaker grills, speaker cones, projection screens, projection screen savers, and all accessories.
- Any defects caused or repairs required as a result of misuse, abusive operation, negligence, improper use and/or insufficient care.
- Any defect caused or repairs required as a result of not following the instructions in the operation manual.
- Any JVC product tampered with, adjusted or repaired by any party other than JVC or authorized JVC Service Centre personnel.

JVC CANADA INC. (ci-après appelé "JVC") énonce la garantie expresse suivante pour tout nouveau produit JVC distribué au Canada par JVC et vendu par un détaillant JVC autorisé.

JVC vous garantit que ce produit est déposé, sous utilisation et entretien normal, de tout défaut matériel et de fabrication sous réserve des modalités et conditions suivantes :

1. Pour obtenir un service de garantie :

- Les produits jvc nécessitant un service doit être présentée avec la preneve d'achat
- Le produit JVC doit être apporté pour service chez un centre de service JVC autorisé.

2. Restrictions:

Cette garantie ne s'applique pas aux :

- Réparation ou remplacement de tout cabinet, batteries, panneau avant, cordons de raccord, antennes, housses de protection, boutons, couverts de haut-parleur, cônes de haut-parleur, écrans de projection, protecteurs d'écran de projection et tous les accessoires.
- Tous défauts occasionnés ou réparations requises suite à une utilisation abusive, mauvaise, négligente et/ou une utilisation incorrecte.
- Tous défauts occasionnés ou réparations requises suite à l'omission de suivre les recommandations du manuel d'instruction.
- Tout produit JVC altéré, ajusté ou réparé par tout autre entreprise que JVC ou un centre de service d'entretien ou de service autorisé JVC.

- (e) Any JVC products on which the serial number has been defaced, modified or removed.
- (f) Maintenance, cleaning or periodic check-up
- (g) Conversion to foreign or domestic voltage or frequency.
- (h) Any JVC product without the Canadian Electrical Safety Regulations ID.
- (i) Any JVC products used for commercial or institutional, rental, or display purposes.
Parts.....1 year (except video head - 90 days)
Labour... 90 days
- (j) Any JVC product which has been resold and no longer owned by the original purchaser.
- (k) Product purchased from "outside Canada", "bankruptcy" or "liquidator".

- (e) Tout produit JVC dont le numéro de série a été altéré, modifié ou enlevé.
- (f) L'entretien, les vérifications périodiques et nettoyage.
- (g) La conversion à une fréquence ou une tension étrangère ou domestique.
- (h) Tout produit JVC n'ayant pas le sigle d'identification conforme aux normes électriques Canadiennes (CSA).
- (i) Pour tout produit utilisé à des fins commerciales, institutionnelles, de location ou utilisé à des fins d'étalage.
Pièces..... 1 An (Excepté les têtes vidéo- 90 jours)
Main d'œuvre... 90 Jours
- (j) Tout produit JVC ayant été revendu et qui n'est plus la propriété de l'acheteur original.
- (k) Produit acheté à "l'extérieur du Canada", provenant d'une "faillite" ou d'un "liquidateur".

- (l) Any defects caused by fire, flood, lightning, power surge, or other events beyond the control of JVC.
- (m) FOR AUTO PRODUCTS
Warranty does not cover elimination of car static or electrical interferences, cleaning of head, adjustments, or labour cost for the removal or reinstallation of the unit for repair.

- (l) Tout dommage causé par le feu, une inondation, un éclair, une surtension ou tout autre évènement hors du contrôle de JVC.
- (m) POUR LES PRODUITS D'AUTOMOBILE
La garantie ne couvre pas l'élimination d'interférences statiques ou électriques de la voiture, le nettoyage de tête, les ajustements et les coûts de main d'œuvre associés à l'enlèvement ou à la réinstallation de l'unité pour réparation.

**WARRANTY TERM (VALID FROM THE DATE OF PURCHASE)
CONDITIONS DE GARANTIE (VALABLE À PARTIR DE LA DATE D'ACHAT)**

PRODUCT PRODUIT	PARTS (Years) PIECES (années)	Labour (Years) MAIN-D'OEUVRE (années)
Projection TV In-Home Service Colour TV In-Home (25" and above) D-ILA Rear Projection In-Home Service LCD TV In-Home Service (25" and above) Écrans de projection Service à Domicile Écrans de TV Couleur Service à Domicile (25" et plus) TV projection arrière D-ILA Service à Domicile Écrans de LCD Service à Domicile (25" et plus)	1	1
<p>* In-home service to be provided where available Where it is not available, the Purchaser must assume the responsibility and expense for the proper packing, shipment and all costs associated with the delivery of the equipment to and from the closest JVC Authorized Service Centre. * Service à domicile fourni par un détaillant disponible. S'il n'y a pas de service JVC disponible à proximité, l'acheteur doit assumer la responsabilité et les coûts pour un emballage adéquat, l'expédition, ainsi que tous les coûts associés à la livraison de l'équipement chez et depuis le détaillant JVC autorisé le plus près pour un service d'entretien.</p>		
Receivers and Home Speakers purchased separately, Front Projection and Car Audio "ARSENAL" Series Récepteurs et Hauts-Parleurs achetés séparément, Projecteur Avant et Audio d'Auto de Série « ARSENAL »	2	2
AC Adapters, Remote Controls, Headphones, Microphones and Projector Lamps Adaptateurs AC, Télécommande, Casque D'écoute, Microphones et Lampe de Projecteur	90 DAYS 90 JOURS	90 DAYS 90 JOURS
Wood Cone Speakers Enceinte à Cône en Bois	5	5
All Other Categories Toutes les autres catégories	1	1

3. Standards:

If any defects should be found in a JVC product within the applicable terms, necessary repairs shall be made at no cost to the purchaser for parts or labour when JVC acknowledges that such defects are due to faulty material or workmanship.

4. Exclusion of All Other Express Warranties:

This warranty constitutes the entire express warranty given by JVC for JVC products and no dealer or service centre personnel or his, its or their agent or employee is, or are authorized to extend or enlarge this warranty on behalf of JVC.

5. Disclaimer of Consequential Damage:

To the extent the law permits JVC disclaims any responsibility for loss of time or use of its product, transportation costs, or any other indirect, incidental or consequential damage or inconvenience.

3. Critères:

Si un produit JVC s'avérait défectueux, selon les conditions applicables, les réparations nécessaires seront effectués sans coûts additionnels à l'acheteur pour les pièces et la main d'œuvre lorsque JVC reconnaît que de telles déficiences sont causées par une déficiences de matériel ou de fabrication.

4. Exclusion de toutes autres garanties expresses :

Cette garantie constitue l'entière garantie express donnée par JVC pour les produits JVC. Nul représentant ou employé d'un détaillant ou d'un service d'entretien n'est autorisé à prolonger cette garantie au nom de JVC.

5. Dénégation des dommages indirects :

Dans la mesure permise par la loi, JVC nie toute responsabilité pour perte de temps ou d'usage de ses produits, des coûts de transport ou tout autre dommage ou inconvénient indirect, accidentel et conséquent.

JVC CANADA INC.

Service toll free # : 1-800-964-2650

E-mail:service@jvc.ca

TO OUR VALUED CUSTOMER ———

THANK YOU FOR PURCHASING THIS JVC PRODUCT.
WE WANT TO HELP YOU ACHIEVE A PERFECT EXPERIENCE.

**NEED HELP ON HOW TO HOOK UP?
NEED ASSISTANCE ON HOW TO OPERATE?
NEED TO LOCATE A JVC SERVICE CENTER?
LIKE TO PURCHASE ACCESSORIES?**

JVC IS HERE TO HELP!
TOLL FREE: 1(800)252-5722
<http://www.jvc.com>

Remember to retain your Bill of Sale for Warranty Service.

————— **Do not attempt to service the product yourself** —————

Caution

To prevent electrical shock, do not open the cabinet.

There are no user serviceable parts inside.

Please refer to qualified service personnel for repairs.

PRODUCT REGISTRATION

We suggest that you register your product since it will enable us to contact you directly if it is ever necessary to correct a safety related condition in your product.

You can register at www.register.jvc.com

Please note that failure to register does not diminish any of your rights during the warranty period.



LIMITED WARRANTY

1-1 **USA ONLY**

ONLY FOR PRODUCT PURCHASED IN U.S.A.

JVC Americas Corp. (JVC) warrants this product and all parts thereof, except as set forth below **ONLY TO THE ORIGINAL RETAIL PURCHASER** to be **FREE FROM DEFECTIVE MATERIALS AND WORKMANSHIP** from the date of original purchase for the period shown below. ("The Warranty Period")

PARTS	1 YR	LABOR	1 YR
-------	-------------	-------	-------------

THIS LIMITED WARRANTY IS VALID ONLY IN THE FIFTY (50) UNITED STATES, THE DISTRICT OF COLUMBIA AND IN THE COMMONWEALTH OF PUERTO RICO.

WHAT WE WILL DO:

If this product is found to be defective within the warranty period, JVC will repair or replace defective parts with new or rebuilt equivalents at no charge to the original owner. Such repair and replacement services shall be rendered by JVC during normal business hours at JVC authorized service centers. Parts used for replacement are warranted only for the remainder of the Warranty Period. All products may be brought to a JVC authorized service center on a carry-in basis. Color televisions with a screen size of 37" class or greater qualify for in-home service. In such cases, a technician will come to your home and either repair the TV there or remove and return it if it cannot be repaired in your home.

WHAT YOU MUST DO FOR WARRANTY SERVICE:

Please do not return your product to the retailer

Instead, return your product to the JVC authorized service center nearest you. If shipping the product to the service center, please be sure to package it carefully, preferably in the original packaging, and include a brief description of the problem(s). Please call 1-800-252-5722 to locate the nearest JVC authorized service center. Service locations can also be obtained from our website <http://www.jvc.com>. If your product qualifies for in-home service, the service representative will require clear access to the product.

If you have any questions concerning your JVC Product, please contact our Customer Care Center at 800-252-5722

WHAT IS NOT COVERED:

This limited warranty provided by JVC does not cover:

1. Products which have been subject to abuse, accident, alteration, modification, tampering, negligence, misuse, faulty installation, lack of reasonable care, or if repaired or serviced by anyone other than a service facility authorized by JVC to render such service, or if affixed to any attachment not provided with the products, or if the model or serial number has been altered, tampered with, defaced or removed;
2. Initial installation, installation and removal from cabinets or mounting systems.
3. Operational adjustments covered in the Owner's Manual, normal maintenance, video and audio head cleaning;
4. Damage that occurs in shipment, due to act of God, and cosmetic damage;
5. Signal reception problems and failures due to line power surge;
6. User Removal Memory Devices/Video Pick-up Tubes/CCD Image Sensors are covered for 90 days from the date of purchase;
7. Accessories;
8. Batteries (except that Rechargeable Batteries are covered for 90 days from the date of purchase);
9. Products used for commercial purposes, including, but not limited to rental.
10. Loss of data resultant from malfunction of hard drive or other data storage device;

There are no express warranties except as listed above.

THE DURATION OF ANY IMPLIED WARRANTIES, INCLUDING THE IMPLIED WARRANTY OF MERCHANTABILITY, IS LIMITED TO THE DURATION OF THE EXPRESS WARRANTY HEREIN.

JVC SHALL NOT BE LIABLE FOR ANY LOSS OF USE OF THE PRODUCT, INCONVENIENCE, OR ANY OTHER DAMAGES, WHETHER DIRECT, INCIDENTAL OR CONSEQUENTIAL (INCLUDING, WITHOUT LIMITATION, DAMAGE TO TAPES, RECORDS OR DISCS) RESULTING FROM THE USE OF THIS PRODUCT, OR ARISING OUT OF ANY BREACH OF THIS WARRANTY. ALL EXPRESS AND IMPLIED WARRANTIES, INCLUDING THE WARRANTIES OF MERCHANTABILITY AND FITNESS FOR PARTICULAR PURPOSE, ARE LIMITED TO THE WARRANTY PERIOD SET FORTH ABOVE.

Some states do not allow the exclusion of incidental or consequential damages or limitations on how long an implied warranty lasts, so these limitations or exclusions may not apply to you. This warranty gives you specific legal rights and you may also have other rights which vary from state to state.

JVC AMERICAS CORP.

1700 Valley Road, Wayne, New Jersey 07470

<http://www.jvc.com>

REFURBISHED PRODUCTS CARRY A SEPARATE WARRANTY, THIS WARRANTY DOES NOT APPLY. FOR DETAIL OF REFURBISHED PRODUCT WARRANTY, PLEASE REFER TO THE REFURBISHED PRODUCT WARRANTY INFORMATION PACKAGED WITH EACH REFURBISHED PRODUCT.

For customer use:

Enter below the Model No. and Serial No. which is located either on the rear, bottom or side of the cabinet. Retain this information for future reference.

Model No. : _____

Serial No. : _____

Purchase date : _____

Name of dealer : _____